

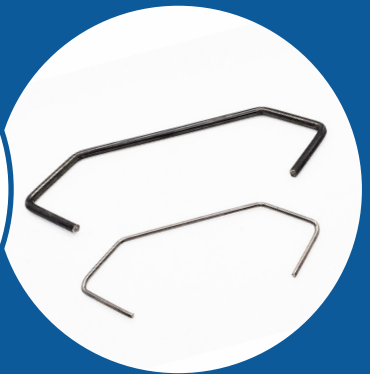

**TOGETHER WE MAKE  
THE DIFFERENCE**

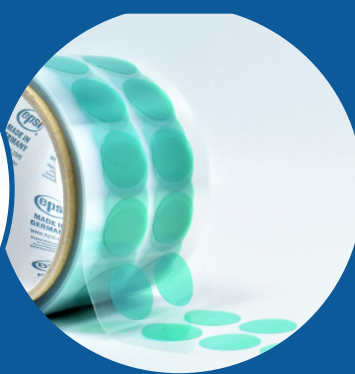

# Capabilities

The EPSI Team is dedicated to improving manufacturing operations around the world. We specialize in designing solutions that improve yield, throughput, safety, and increase life cycles. Our expertise lies in creating non-conductive protective coatings, masking, racking and custom tooling and design. We strive to make manufacturing processes more efficient by reducing the wear and tear on personnel and equipment.

EPSI serves globally, with manufacturing sites in Germany, Texas, Michigan, Tennessee and Wisconsin, and distribution sites in Germany, China, Mexico, the United States and Canada.

Our commitment to logistics, turn times, and reliability make us the trusted choice for some of the top Fortune 500 companies. When it comes to custom tooling, we are the experts.

## Coatings

- » PVC (Plastisol)
- » Powder Coat
- » Wet Paint

## Design & Engineering Services

Our custom engineering services are a cut above the rest. Our team has over a decade of combined experience and expert knowledge of all types of masking and racking. They're dedicated to designing masking and racking that will optimize your equipment's capabilities, with a focus on loading and unloading efficiency, as well as minimizing potential ergonomic complications. Whatever your challenge may be, we'll hit our Proven Process and deliver unique solutions that exceed your expectations.

## Custom Metal & Plastic Fabrication

When evaluating processes and determining solutions, we can help you save money on custom fabrication. In today's metal and plastic finishing industry, it's important to find the most efficient and cost-effective procedures, and we guarantee to provide valuable options. Whether it's a new design or a custom rebuild/repair, our knowledge-based services ensure that you receive the best possible solutions for your operation. With EPSI's expertise in evaluating and implementing fabrication solutions, you can be confident that your customers will receive the high-quality outcome they demand.

## Rebuilds/Repairs

This is where you save. If you have a rack that needs modifications or repairs, our team can help you refurbish re-engineer to meet your needs. We specialize in updating existing racks to ensure they are in top shape and ready to use. Our audit process will suggest the best modifications to your invested hanging concept, so you can get the most out of the rack you already own.

## Laser, Waterjet and Plasma Cutting

## Prototype & Production Builds

## Sandblasting

## Welding – MIG, TIG & Resistance

## 3D Printing

## Burn-Off Services



# Company History

- » A company in the Amtraco Family of Companies
- » Founded in 1976 Franksville, WI by Kissak Sarajian
- » Family Owned and Operated Since 1976
- » Started as a Masking Company Primarily for the Surface Finishing Industry
- » Expanded Into Hook Manufacturing in 2010
- » Expanded Into Custom Racking/Tooling in 2019
- » Over 175 Team Members
- » Locations in the United States, Canada, Mexico, China and Germany

## Your Advantages with EPSI:



### Opportunity Assessment

Gather client data to identify and support client needs. Establish a working partnership. Present EPSI's capabilities.



### Plan Development

Analyze project requirements. Create effective solutions. Gather data to support.



### Design

Engineer product design using 3D modeling software to review with client prior to build.



### Fabricate

Execute a flawlessly built product that exceeds our customers expectations.



### Quality Control

Strict adherence to SOP and QMS processes. ISO 9001 certified.



### Continued Partnership

Foster continued client relationship to identify future partnerships to streamline and maximize client return.

## Industries We Serve

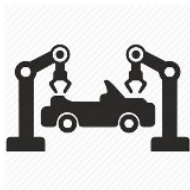

# Product Overview

## Caps



**6**  
SC  
Silicone  
Caps



**10**  
EC  
EPDM  
Caps



**13**  
VC  
Vinyl  
Caps



**16**  
WC  
Washer  
Caps



**18**  
CONE  
EPDM Cone  
Caps



**18**  
CONS  
Silicone Cone  
Caps



**20**  
FSC  
Flat Silicone  
Caps



**22**  
FCS  
Flanged Silicone  
Caps



**23**  
MLC  
Multi Length  
Caps



**24**  
EZY  
Easy  
Caps



**26**  
MBM  
Multi Balloon  
Masking



**27**  
REC  
Rectangular  
Caps



**28**  
Custom  
Masking

## Plugs



**30**  
STS  
Silicone  
Tapered Stoppers



**33**  
HSTS  
Hollow Silicone  
Tapered Stoppers



**34**  
STSH  
Silicone  
Tapered Stoppers  
with Handle



**35**  
CRKR  
Cork  
Stoppers



**36**  
BES  
Black EPDM  
Stoppers



**39**  
FLPS / FLPE  
Flangeless  
Plugs



**40**  
TPP  
Triple Push  
Plugs



**41**  
LTP  
Liqui-Tite  
Plugs



**42**  
BTM  
Blind-Hole Thread  
Mask Plugs



**43**  
C-BTM  
Blind Thread  
Collar Plugs



**44**  
GWPP  
Weld-Nut  
Pull Plugs



**45**  
SPP  
Silicone  
Pull Plugs



**48**  
EPP  
EPDM  
Pull Plugs



**50**  
MSPP  
Multi Step  
Pull Plugs



**51**  
EMT/SMT  
Mousetail  
Plugs



**52**  
CPP  
Flex-Tite  
Countersink  
Pull Plugs



**53**  
DWP  
Double  
Washer Plugs



**54**  
C-DWP  
Double Washer Plug  
w/ colored tip



**55**  
DFP  
Dual Flanged  
Push Plugs

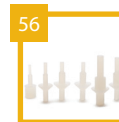

**56**  
SOMS  
Sink-O-Mask  
Plugs



**57**  
SMS  
Silicone  
Modular Stoppers



**58**  
TSS  
Silicone  
Stems



**59**  
TNM  
Thread-N-Mask  
Plugs



**60**  
ETNM  
Ergonomic  
Thread-N-Mask  
Plug



**61**  
TIPS  
Tube Insert  
Plugs



**62**  
TOPS  
Shallow Tube  
Plugs



**63**  
WP  
Washer  
Plugs



**65**  
TPSP  
Port-Tite  
Plugs



**66**  
HTP  
Hang-Tite  
Plugs

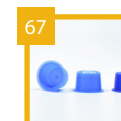

**67**  
TCP  
Tapered Cap  
& Plug



**72**  
NTS  
Neoprene  
Tapered Stopper

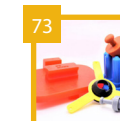

**73**  
Custom  
Masking

## Tapes & Discs



**74**  
A12  
Green  
Poly Tape



**76**  
AD12  
Green  
Poly Discs



**78**  
AH12  
Green  
Poly Donuts



**79**  
AW12  
Green  
Wishbone Discs



**81**  
B12  
Blue  
Poly Tape



**82**  
IDT Blue  
Blue  
Poly Tape



**83**  
D12  
Red  
Poly Tape



**84**  
O12  
Orange  
Poly Tape



**86**  
SPVC  
Sandblasting  
Tape



**87**  
F12  
Fiberglass  
Tape



**88**  
FD12  
Fiberglass  
Discs



**89**  
K22  
Polyimide  
Tape



**90**  
KD22  
Polyimide  
Discs



**91**  
K12  
Polyimide  
Tape



**92**  
3M2380  
3M Crepe  
Tape



**93**  
C21  
Crepe  
Tape



**CD21**  
Crepe  
Discs



**IPG PG21**  
Crepe  
Tape



**V10**  
General Purpose  
Vinyl Tape



**V12**  
Electroplating  
Vinyl Tape



**V71**  
Non-Adhesive  
Vinyl Tape



**S10/20/30**  
Silicone  
Self-Fusing Tape

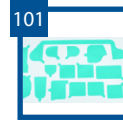

**Custom  
tape-cuts**

## Hooks

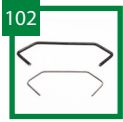

**HV**  
V-Hooks

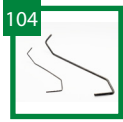

**HV90**  
V-Hooks  
90° twist

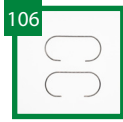

**HC**  
C-Hooks

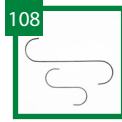

**HS**  
S-Hooks

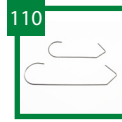

**HCV**  
CV-Hooks

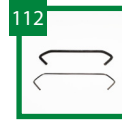

**HKD**  
Diamond Hooks

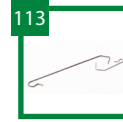

**HKVL**  
V-Style  
Locking Hooks

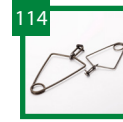

**CLAW**  
CLAW  
Hooks



**SWIVEL**  
Swivel  
Hooks



**HKSC**  
Sheet & Pipe  
Suspender Hooks



**HKRO**  
Spring Tube  
Hooks

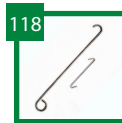

**Custom  
Wire Forms**

## Tubing, Cords & Sheeting



**ST**  
Silicone  
Tubing



**FSTS**  
Flexible Star  
Tubing



**CRDS**  
Solid Silicone  
Cord



**CRDF**  
Silicone Foam  
Cord



**SHFS**  
Silicone Foam  
Sheet



**SHRS**  
Solid Silicone  
Sheet

## Miscellaneous



**KIT**  
Starter Kits  
Caps & Plugs



**PTS**  
Paint Touch-up  
Stick



**CRSP**  
Cork  
Spacer Pads

## Racking



**CNC**  
Cross-N-Click

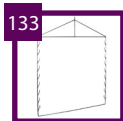

**MRF**  
Modular  
Racking Frame

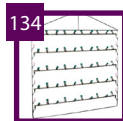

**BGT**  
Diamond  
XBar



**BGT Tips**  
Diamond  
XBar Tips

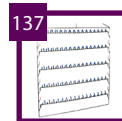

**HGT**  
Round  
XBar

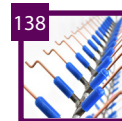

**HGT Tips**  
Round  
XBar Tips



**PLT**  
Profile  
XBar



**SB**  
Standard  
Crossbar

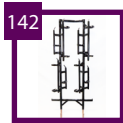

**Custom  
Racking**



## Silicone Caps

Heat resistant up to 600°F (315°C)

Material: Silicone

Duro: 55 +/- 5 Shore

- » When sizing parts as a cap, the ID of the cap should be 2-5% smaller than the stud diameter
- » To ensure easy removal, select a cap length that is slightly longer than the masking length of the stud. This is especially important if the cap ID is less than 5% of the stud diameter
- » When sizing parts as a plug, the OD should be at least 7% larger than the hole diameter
- » When using to cover tube ends in powder coating, cut a small slit in the top of the cap to prevent blow off (See EZY™ Caps)
- » Can be used as a cap and a plug
- » Flexible enough to conform to irregular geometry
- » Round top profile allows for easy insertion into holes
- » Silicone Caps are reusable and will not melt or harden
- » Color coded for increased visibility and easy sorting during reuse

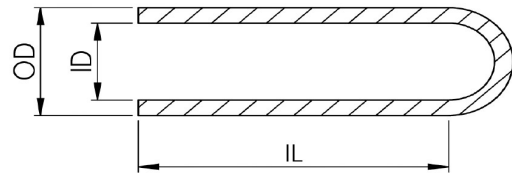

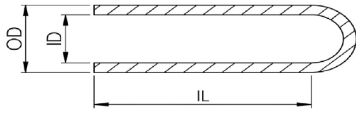

# SC

Part number	Color	ID (in)	OD (in)	IL (in)	ID (mm)	OD (mm)	IL (mm)	pcs/bag
SC 0020X0500-R	red	0.020	0.080	0.500	0.5	2.0	12.7	1000
SC 0028X0500-C	clear	0.028	0.088	0.500	0.7	2.2	12.7	1000
SC 0035X0500-W	white	0.035	0.095	0.500	0.9	2.4	12.7	1000
SC 0040X0750-U	blue	0.040	0.130	0.750	1.0	3.3	19.1	1000
SC 0062X0750-L	yellow	0.062	0.152	0.750	1.6	3.9	19.1	1000
SC 0070X1000-G	green	0.070	0.160	1.000	1.8	4.1	25.4	1000
SC 0080X0750-O	orange	0.080	0.200	0.750	2.0	5.1	19.1	1000
SC 0093X0500-N	pink	0.093	0.213	0.500	2.4	5.4	12.7	1000
SC 0093X0750-N	pink	0.093	0.193	0.750	2.4	4.9	19.1	1000
SC 0100X0500-G	green	0.100	0.200	0.500	2.5	5.1	12.7	1000
SC 0100X1000-G	green	0.100	0.200	1.000	2.5	5.1	25.4	1000
SC 0109X0500-L	yellow	0.109	0.229	0.500	2.8	5.8	12.7	1000
SC 0109X0750-Y	grey	0.109	0.209	0.750	2.8	5.3	19.1	1000
SC 0125X0500-U	blue	0.125	0.225	0.500	3.2	5.7	12.7	1000
SC 0125X1000-B	black	0.125	0.225	1.000	3.2	5.7	25.4	1000
SC 0125X1000-L	yellow	0.125	0.225	1.000	3.2	5.7	25.4	1000
SC 0125X1500	clear	0.125	0.245	1.500	3.2	6.2	38.1	1000
SC 0135X0625	clear	0.135	0.255	0.625	3.4	6.5	15.9	1000
SC 0140X0250-W	white	0.140	0.260	0.250	3.6	6.6	6.4	1000
SC 0140X0500	clear	0.140	0.260	0.500	3.6	6.6	12.7	1000
SC 0140X1000-W	white	0.140	0.260	1.000	3.6	6.6	25.4	1000
SC 0140X1500	clear	0.140	0.260	1.500	3.6	6.6	38.1	1000
SC 0148X0500-N	pink	0.148	0.268	0.500	3.8	6.8	12.7	1000
SC 0148X0750-N	pink	0.148	0.268	0.750	3.8	6.8	19.1	1000
SC 0148X1000-N	pink	0.148	0.268	1.000	3.8	6.8	25.4	1000
SC 0156X0500-G	green	0.156	0.276	0.500	4.0	7.0	12.7	1000
SC 0156X1000-L	yellow	0.156	0.276	1.000	4.0	7.0	25.4	1000
SC 0172X0500-Y	grey	0.172	0.292	0.500	4.4	7.4	12.7	1000
SC 0172X1000-U	blue	0.172	0.292	1.000	4.4	7.4	25.4	1000
SC 0172X1500-U	blue	0.172	0.292	1.500	4.4	7.4	38.1	1000
SC 0180X1000-B	black	0.180	0.300	1.000	4.6	7.6	25.4	1000
SC 0187X0500-W	white	0.187	0.307	0.500	4.7	7.8	12.7	1000
SC 0187X1000	clear	0.187	0.307	1.000	4.7	7.8	25.4	1000
SC 0187X1500	clear	0.187	0.307	1.500	4.7	7.8	38.1	1000
SC 0197X0500-Z	brown	0.197	0.317	0.500	5.0	8.1	12.7	1000
SC 0218X1000-Y	grey	0.218	0.338	1.000	5.5	8.6	25.4	1000
SC 0223X0500-N	pink	0.223	0.343	0.500	5.7	8.7	12.7	1000
SC 0223X0750-U	blue	0.223	0.343	0.750	5.7	8.7	19.1	1000
SC 0223X1000-N	pink	0.223	0.343	1.000	5.7	8.7	25.4	1000
SC 0223X1500-N	pink	0.223	0.343	1.500	5.7	8.7	38.1	1000

# SC

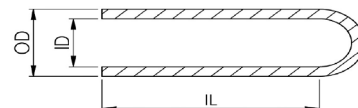

Part number	Color	ID (in)	OD (in)	IL (in)	ID (mm)	OD (mm)	IL (mm)	pcs/bag
SC 0234X0500-G	green	0.234	0.354	0.500	5.9	9.0	12.7	1000
SC 0234X0787-G	green	0.234	0.354	0.787	5.9	9.0	20.0	1000
SC 0234X1000-G	green	0.234	0.354	1.000	5.9	9.0	25.4	1000
SC 0234X1500-L	yellow	0.234	0.354	1.500	5.9	9.0	38.1	1000
SC 0250X1000-Y	grey	0.250	0.370	1.000	6.4	9.4	25.4	1000
SC 0250X1500	clear	0.250	0.370	1.500	6.4	9.4	38.1	1000
SC 0260X1000-O	orange	0.260	0.380	1.000	6.6	9.7	25.4	500
SC 0281X1000-U	blue	0.281	0.401	1.000	7.1	10.2	25.4	500
SC 0281X1000	clear	0.281	0.401	1.000	7.1	10.2	25.4	500
SC 0295X0500-B	black	0.295	0.415	0.500	7.5	10.5	12.7	500
SC 0295X0750-B	black	0.295	0.415	0.750	7.5	10.5	19.1	500
SC 0295X1000-B	black	0.295	0.415	1.000	7.5	10.5	25.4	500
SC 0295X1500-B	black	0.295	0.415	1.500	7.5	10.5	38.1	500
SC 0312X1000-W	white	0.312	0.432	1.000	7.9	11.0	25.4	500
SC 0312X1500-N	pink	0.312	0.432	1.500	7.9	11.0	38.1	500
SC 0312X2000-W	white	0.312	0.432	2.000	7.9	11.0	50.8	500
SC 0340X1000-P	purple	0.340	0.460	1.000	8.6	11.7	25.4	500
SC 0340X2000	clear	0.340	0.460	2.000	8.6	11.7	50.8	500
SC 0355X1000	clear	0.355	0.475	1.000	9.0	12.1	25.4	500
SC 0355X1500-G	green	0.355	0.475	1.500	9.0	12.1	38.1	500
SC 0366X1500-R	red	0.366	0.486	1.500	9.3	12.3	38.1	500
SC 0375X0750-L	yellow	0.375	0.495	0.750	9.5	12.6	19.1	500
SC 0375X1000-L	yellow	0.375	0.495	1.000	9.5	12.6	25.4	500
SC 0375X1500-Y	grey	0.375	0.495	1.500	9.5	12.6	38.1	500
SC 0406X1000-U	blue	0.406	0.526	1.000	10.3	13.4	25.4	250
SC 0437X1000-B	black	0.437	0.557	1.000	11.1	14.1	25.4	250
SC 0456X0500	clear	0.456	0.556	0.500	11.6	14.1	12.7	250
SC 0456X1500	clear	0.456	0.556	1.500	11.6	14.1	38.1	250
SC 0468X1000-W	white	0.468	0.588	1.000	11.9	14.9	25.4	250
SC 0480X1500-N	pink	0.480	0.600	1.500	12.2	15.2	38.1	250
SC 0500X1500-G	green	0.500	0.620	1.500	12.7	15.7	38.1	250
SC 0535X1500-U	blue	0.535	0.635	1.500	13.6	16.1	38.1	250
SC 0535X1500	clear	0.535	0.635	1.500	13.6	16.1	38.1	250
SC 0535X3000	clear	0.535	0.655	3.000	13.6	16.6	76.2	250



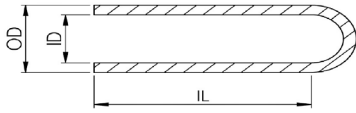

# SC

Part number	Color	ID (in)	OD (in)	IL (in)	ID (mm)	OD (mm)	IL (mm)	pcs/bag
SC 0562X1500	clear	0.562	0.682	1.500	14.3	17.3	38.1	250
SC 0590X4720	clear	0.590	0.710	4.720	15.0	18.0	119.9	100
SC 0600X1500	clear	0.600	0.708	1.500	15.2	18.0	38.1	250
SC 0625X1125	clear	0.625	0.745	1.125	15.9	18.9	28.6	250
SC 0625X1500	clear	0.625	0.745	1.500	15.9	18.9	38.1	250
SC 0625X2500	clear	0.625	0.745	2.500	15.9	18.9	63.5	250
SC 0687X1000	clear	0.687	0.807	1.000	17.4	20.5	25.4	100
SC 0687X1500	clear	0.687	0.807	1.500	17.4	20.5	38.1	100
SC 0730X1500	clear	0.730	0.850	1.500	18.5	21.6	38.1	100
SC 0750X1500	clear	0.750	0.870	1.500	19.1	22.1	38.1	100
SC 0750X3500	clear	0.750	0.870	3.500	19.1	22.1	88.9	100
SC 0780X1500	clear	0.780	0.900	1.500	19.8	22.9	38.1	100
SC 0812X1500	clear	0.812	0.932	1.500	20.6	23.7	38.1	100
SC 0875X1500	clear	0.875	0.995	1.500	22.2	25.3	38.1	100
SC 0937X1500	clear	0.937	1.057	1.500	23.8	26.8	38.1	100
SC 0970X1500	clear	0.970	1.090	1.500	24.6	27.7	38.1	100
SC 0970X4000	clear	0.970	1.090	4.000	24.6	27.7	101.6	100
SC 1000X1500	clear	1.000	1.120	1.500	25.4	28.4	38.1	100
SC 1000X2000	clear	1.000	1.120	2.000	25.4	28.4	50.8	100
SC 1062X2000	clear	1.062	1.182	2.000	27.0	30.0	50.8	100
SC 1125X1500	clear	1.125	1.245	1.500	28.6	31.6	38.1	100
SC 1187X1500	clear	1.187	1.307	1.500	30.1	33.2	38.1	100
SC 1250X1500	clear	1.250	1.370	1.500	31.8	34.8	38.1	100
SC 1350X1500	clear	1.350	1.470	1.500	34.3	37.3	38.1	100
SC 1350X1750	clear	1.350	1.470	1.750	34.3	37.3	44.5	100
SC 1380X1000	clear	1.380	1.500	1.000	35.1	38.1	25.4	50
SC 1500X1000	clear	1.500	1.620	1.000	38.1	41.1	25.4	50
SC 1500X1500	clear	1.500	1.620	1.500	38.1	41.1	38.1	50
SC 1500X1750	clear	1.500	1.620	1.750	38.1	41.1	44.5	50
SC 1625X2000	clear	1.625	1.745	2.000	41.3	44.3	50.8	50
SC 1750X1500	clear	1.750	1.870	1.500	44.5	47.5	38.1	50
SC 1750X2000	clear	1.750	1.870	2.000	44.5	47.5	50.8	50
SC 1875X2000	clear	1.875	1.995	2.000	47.6	50.7	50.8	50
SC 2000X2000	clear	2.000	2.120	2.000	50.8	53.8	50.8	25

Current pricing and additional sizes available at [www.epsi.com](http://www.epsi.com)

Not all sizes are available in all warehouse locations - please check with your local sales rep for lead time and availability





## EPDM Caps

Heat resistant up to 475°F (250°C)

Material: EPDM

Duro: 55 +/- 5 Shore

- » When sizing parts as a cap, the ID of the cap should be 2-5% smaller than the stud diameter
- » To ensure easy removal, select a cap length that is slightly longer than the masking length of the stud. This is especially important if the cap ID is less than 5% of the stud diameter
- » When sizing parts as a plug, the OD should be at least 7% larger than the hole diameter
- » When using to cover tube ends in powder coating, cut a small slit in the top of the cap to prevent blow off (See EZY™ Caps)
- » Can be used as a cap and a plug
- » Flexible enough to conform to irregular geometry
- » Round top profile allows for easy insertion into holes
- » EPDM caps are reusable and have excellent chemical resistance
- » Economical enough to be used one time in high temperature applications or where the cap will be used during shipping after coating process

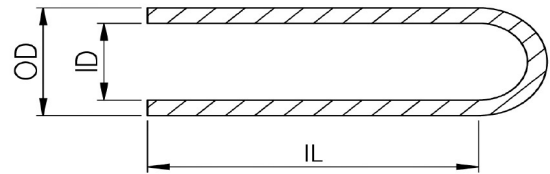

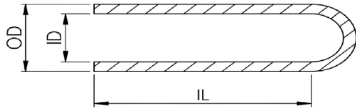

# EC

Part number	Color	ID (in)	OD (in)	IL (in)	ID (mm)	OD (mm)	IL (mm)	pcs/bag
EC 0040X0750	black	0.040	0.130	0.750	1.0	3.3	19.1	1000
EC 0062X0750	black	0.062	0.152	0.750	1.6	3.9	19.1	1000
EC 0100X1000	black	0.100	0.200	1.000	2.5	5.1	25.4	1000
EC 0109X0500	black	0.109	0.229	0.500	2.8	5.8	12.7	1000
EC 0109X0750	black	0.109	0.209	0.750	2.8	5.3	19.1	1000
EC 0125X0500	black	0.125	0.225	0.500	3.2	5.7	12.7	1000
EC 0125X1000	black	0.125	0.225	1.000	3.2	5.7	25.4	1000
EC 0140X0250	black	0.140	0.260	0.250	3.6	6.6	6.4	1000
EC 0140X1000	black	0.140	0.260	1.000	3.6	6.6	25.4	1000
EC 0148X1000	black	0.148	0.268	1.000	3.8	6.8	25.4	1000
EC 0156X0500	black	0.156	0.276	0.500	4.0	7.0	12.7	1000
EC 0156X1000	black	0.156	0.276	1.000	4.0	7.0	25.4	1000
EC 0172X0500	black	0.172	0.292	0.500	4.4	7.4	12.7	1000
EC 0172X1000	black	0.172	0.292	1.000	4.4	7.4	25.4	1000
EC 0180X1000	black	0.180	0.300	1.000	4.6	7.6	25.4	1000
EC 0187X0500	black	0.187	0.307	0.500	4.7	7.8	12.7	1000
EC 0187X1000	black	0.187	0.307	1.000	4.7	7.8	25.4	1000
EC 0197X0500	black	0.197	0.317	0.500	5.0	8.1	12.7	1000
EC 0218X1000	black	0.218	0.338	1.000	5.5	8.6	25.4	1000
EC 0223X1000	black	0.223	0.343	1.000	5.7	8.7	25.4	1000
EC 0223X1500	black	0.223	0.343	1.500	5.7	8.7	38.1	1000
EC 0234X0500	black	0.234	0.354	0.500	5.9	9.0	12.7	1000
EC 0234X0787	black	0.234	0.354	0.787	5.9	9.0	20.0	1000
EC 0234X1000	black	0.234	0.354	1.000	5.9	9.0	25.4	1000
EC 0234X1500	black	0.234	0.354	1.500	5.9	9.0	38.1	1000
EC 0250X1000	black	0.250	0.370	1.000	6.4	9.4	25.4	1000
EC 0295X0500	black	0.295	0.415	0.500	7.5	10.5	12.7	500
EC 0295X0750	black	0.295	0.415	0.750	7.5	10.5	19.1	500
EC 0295X1000	black	0.295	0.415	1.000	7.5	10.5	25.4	500
EC 0295X1500	black	0.295	0.415	1.500	7.5	10.5	38.1	500
EC 0312X1000	black	0.312	0.432	1.000	7.9	11.0	25.4	500
EC 0312X1500	black	0.312	0.432	1.500	7.9	11.0	38.1	500
EC 0340X1000	black	0.340	0.460	1.000	8.6	11.7	25.4	500
EC 0355X1500	black	0.355	0.475	1.500	9.0	12.1	38.1	500
EC 0366X1500	black	0.366	0.486	1.500	9.3	12.3	38.1	500
EC 0375X1000	black	0.375	0.495	1.000	9.5	12.6	25.4	500
EC 0375X1500	black	0.375	0.495	1.500	9.5	12.6	38.1	500
EC 0437X1000	black	0.437	0.557	1.000	11.1	14.1	25.4	250
EC 0456X1500	black	0.456	0.556	1.500	11.6	14.1	38.1	250
EC 0468X1000	black	0.468	0.588	1.000	11.9	14.9	25.4	250

# EC

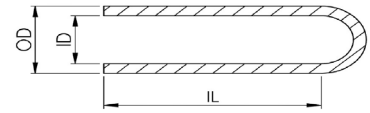

Part number	Color	ID (in)	OD (in)	IL (in)	ID (mm)	OD (mm)	IL (mm)	pcs/bag
EC 0500X1500	black	0.500	0.620	1.500	12.7	15.7	38.1	250
EC 0535X1500	black	0.535	0.635	1.500	13.6	16.1	38.1	250
EC 0535X3000	black	0.535	0.655	3.000	13.6	16.6	76.2	250
EC 0600X1500	black	0.600	0.708	1.500	15.2	18.0	38.1	250
EC 0625X1500	black	0.625	0.745	1.500	15.9	18.9	38.1	250
EC 0750X1500	black	0.750	0.870	1.500	19.1	22.1	38.1	100
EC 0812X1500	black	0.812	0.932	1.500	20.6	23.7	38.1	100
EC 0875X1500	black	0.875	0.995	1.500	22.2	25.2	38.1	100
EC 1000X2000	black	1.000	1.120	2.000	25.4	28.4	50.8	100
EC 1062X2000	black	1.062	1.182	2.000	27.0	30.0	50.8	100
EC 1125X1500	black	1.125	1.245	1.500	28.6	31.6	38.1	100
EC 1250X1500	black	1.250	1.370	1.500	31.8	34.8	38.1	100
EC 1500X1750	black	1.500	1.620	1.750	38.1	41.1	44.5	50
EC 1625X2000	black	1.625	1.745	2.000	41.3	44.3	50.8	50
EC 1750X2000	black	1.750	1.870	2.000	44.5	47.5	50.8	50
EC 1875X2000	black	1.875	1.995	2.000	47.6	50.7	50.8	50
EC 2000X2000	black	2.000	2.120	2.000	50.8	53.8	50.8	25

Current pricing and additional sizes available at [www.epsi.com](http://www.epsi.com)

Not all sizes are available in all warehouse locations - please check with your local sales rep for lead time and availability





## Vinyl Caps

Heat resistant up to 212°F (100°C)

Material: Vinyl

Duro: 55 +/- 5 Shore

- » economical alternative to Silicone and EPDM Caps
- » protects parts from debris and contamination during shipping
- » when sizing, ID of cap should be 5-7% smaller than OD of stud

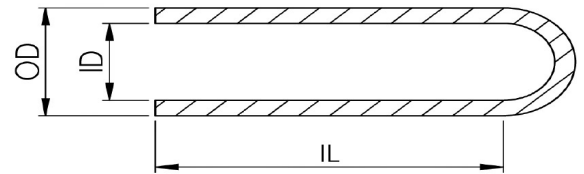

# VC

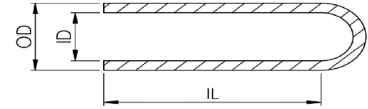

Part number	Color	ID (in)	OD (in)	IL (in)	ID (mm)	OD (mm)	IL (mm)	pcs/bag
VC 0054X0625	black	0.054	0.090	0.625	1.4	2.3	15.9	1000
VC 0062X0625	black	0.062	0.120	0.625	1.6	3.0	15.9	1000
VC 0080X0625	black	0.080	0.140	0.625	2.0	3.6	15.9	1000
VC 0093X0750	black	0.093	0.150	0.750	2.4	3.8	19.1	1000
VC 0125X0500	black	0.125	0.200	0.500	3.2	5.1	12.7	1000
VC 0125X1000	black	0.125	0.200	1.000	3.2	5.1	25.4	1000
VC 0140X0500	black	0.140	0.210	0.500	3.6	5.3	12.7	1000
VC 0140X1000	black	0.140	0.210	1.000	3.6	5.3	25.4	1000
VC 0156X0500	black	0.156	0.240	0.500	4.0	6.1	12.7	1000
VC 0156X1000	black	0.156	0.240	1.000	4.0	6.1	25.4	1000
VC 0172X0500	black	0.172	0.250	0.500	4.4	6.4	12.7	1000
VC 0172X1000	black	0.172	0.250	1.000	4.4	6.4	25.4	1000
VC 0187X0500	black	0.187	0.270	0.500	4.7	6.9	12.7	1000
VC 0187X1000	black	0.187	0.270	1.000	4.7	6.9	25.4	1000
VC 0203X0500	black	0.203	0.290	0.500	5.2	7.4	12.7	1000
VC 0203X1000	black	0.203	0.290	1.000	5.2	7.4	25.4	1000
VC 0218X0500	black	0.218	0.310	0.500	5.5	7.9	12.7	1000
VC 0218X1000	black	0.218	0.310	1.000	5.5	7.9	25.4	1000
VC 0234X0500	black	0.234	0.320	0.500	5.9	8.1	12.7	1000
VC 0250X1000	black	0.250	0.350	1.000	6.4	8.9	25.4	1000
VC 0281X0500	black	0.281	0.380	0.500	7.1	9.7	12.7	500
VC 0281X1000	black	0.281	0.380	1.000	7.1	9.7	25.4	500
VC 0312X0500	black	0.312	0.420	0.500	7.9	10.7	12.7	500
VC 0312X1000	black	0.312	0.420	1.000	7.9	10.7	25.4	500
VC 0343X0500	black	0.343	0.450	0.500	8.7	11.4	12.7	500
VC 0343X1000	black	0.343	0.450	1.000	8.7	11.4	25.4	500
VC 0375X0500	black	0.375	0.500	0.500	9.5	12.7	12.7	500
VC 0375X1000	black	0.375	0.500	1.000	9.5	12.7	25.4	500
VC 0406X0500	black	0.406	0.530	0.500	10.3	13.5	12.7	250
VC 0406X1000	black	0.406	0.530	1.000	10.3	13.5	25.4	250
VC 0437X0500	black	0.437	0.560	0.500	11.1	14.2	12.7	250
VC 0437X1000	black	0.437	0.560	1.000	11.1	14.2	25.4	250
VC 0500X0500	black	0.500	0.620	0.500	12.7	15.7	12.7	250
VC 0500X1000	black	0.500	0.620	1.000	12.7	15.7	25.4	250
VC 0531X0500	black	0.531	0.650	0.500	13.5	16.5	12.7	250
VC 0531X1000	black	0.531	0.650	1.000	13.5	16.5	25.4	250
VC 0562X0500	black	0.562	0.690	0.500	14.3	17.5	12.7	250
VC 0562X1000	black	0.562	0.690	1.000	14.3	17.5	25.4	250

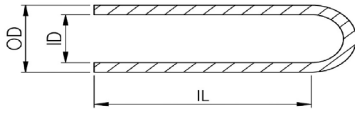

# VC

Part number	Color	ID (in)	OD (in)	IL (in)	ID (mm)	OD (mm)	IL (mm)	pcs/bag
VC 0625X0500	black	0.625	0.760	0.500	15.9	19.3	12.7	250
VC 0625X1000	black	0.625	0.760	1.000	15.9	19.3	25.4	250
VC 0687X0500	black	0.687	0.810	0.500	17.4	20.6	12.7	100
VC 0687X1000	black	0.687	0.810	1.000	17.4	20.6	25.4	100
VC 0750X0500	black	0.750	0.880	0.500	19.1	22.4	12.7	100
VC 0750X1000	black	0.750	0.880	1.000	19.1	22.4	25.4	100
VC 0812X0500	black	0.812	0.940	0.500	20.6	23.9	12.7	100
VC 0812X1000	black	0.812	0.940	1.000	20.6	23.9	25.4	100
VC 0875X0500	black	0.875	1.020	0.500	22.2	25.9	12.7	100
VC 0875X1000	black	0.875	1.020	1.000	22.2	25.9	25.4	100
VC 0937X0500	black	0.937	1.080	0.500	23.8	27.4	12.7	100
VC 0937X1000	black	0.937	1.080	1.000	23.8	27.4	25.4	100
VC 1000X0500	black	1.000	1.140	0.500	25.4	29.0	12.7	100
VC 1000X1000	black	1.000	1.140	1.000	25.4	29.0	25.4	100
VC 1062X1000	black	1.062	1.200	1.000	27.0	30.5	25.4	100
VC 1125X1000	black	1.125	1.270	1.000	28.6	32.3	25.4	100
VC 1187X1000	black	1.187	1.330	1.000	30.1	33.8	25.4	100
VC 1250X1000	black	1.250	1.390	1.000	31.8	35.3	25.4	100
VC 1375X1000	black	1.375	1.520	1.000	34.9	38.6	25.4	100
VC 1500X1000	black	1.500	1.640	1.000	38.1	41.7	25.4	50
VC 1625X1000	black	1.625	1.770	1.000	41.3	45.0	25.4	50
VC 1750X1000	black	1.750	1.890	1.000	44.5	48.0	25.4	50
VC 1875X1000	black	1.875	2.020	1.000	47.6	51.3	25.4	25
VC 2000X1000	black	2.000	2.140	1.000	50.8	54.4	25.4	25
VC 2250X1000	black	2.250	2.400	1.000	57.2	61.0	25.4	25
VC 2250X1500	black	2.250	2.400	1.500	57.2	61.0	38.1	25
VC 2375X1000	black	2.375	2.520	1.000	60.3	64.0	25.4	25
VC 2500X1000	black	2.500	2.650	1.000	63.5	67.3	25.4	25
VC 2750X1000	black	2.750	2.910	1.000	69.9	73.9	25.4	25
VC 2875X1000	black	2.875	3.030	1.000	73.0	77.0	25.4	25
VC 3125X1000	black	3.125	3.280	1.000	79.4	83.3	25.4	25
VC 3255X1125	black	3.255	3.410	1.125	82.7	86.6	28.6	25
VC 3500X1125	black	3.500	3.660	1.125	88.9	93.0	28.6	25
VC 4250X1250	black	4.250	4.410	1.250	108.0	112.0	31.8	25

Current pricing and additional sizes available at [www.epsi.com](http://www.epsi.com)

Not all sizes are available in all warehouse locations - please check with your local sales rep for lead time and availability



# W/C



## Washer Caps

Heat resistant up to 600°F (315°C)

Material: Silicone

Duro: 55 +/- 5 Shore

- » For other washer diameters, EPSI can die-cut a silicone foam donut shaped washer or donut tape die-cut to be used under the cap
- » SC-series caps can be nested inside the washer cap to create smaller ID's
- » Can be used as a cap and a plug
- » Washer creates area free from powder for assembly purposes
- » Flexible enough to conform to irregular geometry
- » Washer feature creates area free from powder for assembly purposes
- » When sizing as cap select an ID that is 2-3% smaller than the stud
- » When sizing as a plug select an OD that is 5-7% larger than the hole

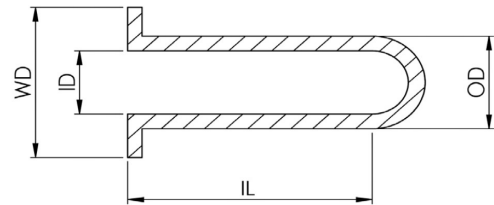



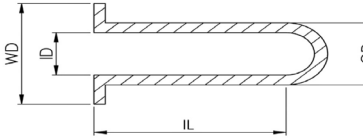

# WC

Part number	Color	ID (in)	OD (in)	IL (in)	WD (in)	ID (mm)	OD (mm)	IL (mm)	WD (mm)	pcs/bag
WC 0106X0472-G	green	0.106	0.246	1.000	0.472	2.7	6.2	25.4	12.0	500
WC 0125X0500	clear	0.125	0.265	1.000	0.500	3.2	6.7	25.4	12.7	500
WC 0140X0500	clear	0.140	0.320	1.000	0.500	3.6	8.1	25.4	12.7	500
WC 0146X0472-N	pink	0.146	0.266	1.000	0.472	3.7	6.8	25.4	12.0	500
WC 0156X0500	clear	0.156	0.316	1.000	0.500	4.0	8.0	25.4	12.7	500
WC 0172X0500	clear	0.172	0.372	1.000	0.500	4.4	9.4	25.4	12.7	500
WC 0180X0600-G	green	0.180	0.320	1.000	0.600	4.6	8.1	25.4	15.2	500
WC 0220X0590-R	red	0.220	0.360	1.000	0.590	5.6	9.1	25.4	15.0	500
WC 0220X0787	clear	0.220	0.340	1.000	0.787	5.6	8.6	25.4	20.0	500
WC 0240X0500-F	rusty	0.240	0.360	1.000	0.500	6.1	9.1	25.4	12.7	250
WC 0295X0700-B	black	0.295	0.435	1.000	0.700	7.5	11.0	25.4	17.8	250
WC 0300X0675	clear	0.300	0.420	1.000	0.675	7.6	10.7	25.4	17.1	250
WC 0354X0787-N	pink	0.354	0.474	1.000	0.787	9.0	12.0	25.4	20.0	250
WC 0375X0825-L	yellow	0.375	0.495	1.000	0.825	9.5	12.6	25.4	21.0	250
WC 0453X0984	clear	0.453	0.653	1.500	0.984	11.5	16.6	38.1	25.0	250
WC 0460X0700	clear	0.460	0.580	1.000	0.700	11.7	14.7	25.4	17.8	250
WC 0500X1000	clear	0.500	0.620	1.000	1.000	12.7	15.7	25.4	25.4	250
WC 0615X1180-F	rusty	0.615	0.800	1.500	1.180	15.6	20.3	38.1	30.0	250
WC 0780X1475-Y	grey	0.780	0.980	1.500	1.475	19.8	24.9	38.1	37.4	250

Current pricing and additional sizes available at [www.epsi.com](http://www.epsi.com)

Not all sizes are available in all warehouse locations - please check with your local sales rep for lead time and availability



# CON



## Cone & Cons Caps

- » Versatile enough to be used as caps, stoppers or plugs in any variety of applications
- » When sizing parts as a cap, the ID of the cap should be 2 - 5% smaller than the stud diameter
- » To ensure easy removal, select a cap length that is at least 1/4" longer than the masking length of the stud. This is especially important if the cap ID is less than 5% of the stud diameter
- » Conical profile allows for easy insertion as a plug
- » Washer feature creates area free from powder for assembly purposes
- » Will fit multiple diameter threads when used as a cap
- » Flexible enough to conform to irregular geometry and great for square holes
- » Silicone Cone Caps are reusable and will not melt or harden
- » When sizing parts as a plug, the MJD (major diameter) should be 2 - 5% larger than the ID of the hole you are plugging

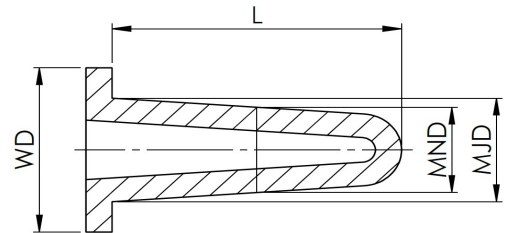

# CONE

## EPDM Cone Caps

Heat resistant up to 475°F (245°C)

Material: EPDM

Duro: 65 +/- 5 Shore

Part number	Color	MJD (in)	MND (in)	WD (in)	L (in)	MJD (mm)	MND (mm)	WD (mm)	L (mm)	pcs/bag
CONE 00613-B	black	0.250	0.071	0.500	0.906	6.3	1.8	12.7	23.0	500
CONE 00813-B	black	0.316	0.099	0.500	1.000	8.0	2.5	12.7	25.4	500
CONE 00916-B	black	0.335	0.111	0.625	1.000	8.5	2.8	15.9	25.4	500
CONE 01017-B	black	0.394	0.137	0.650	1.102	10.0	3.5	16.5	28.0	500
CONE 01116-B	black	0.400	0.139	0.635	1.100	10.1	3.5	16.1	27.9	250
CONE 01419-B	black	0.551	0.199	0.750	1.417	14.0	5.1	19.1	36.0	250
CONE 01725-B	black	0.689	0.266	0.980	1.500	17.5	6.6	24.9	38.1	250
CONE 02028-B	black	0.767	0.270	1.100	2.009	19.5	6.9	27.9	51.0	100
CONE 02125-B	black	0.819	0.304	1.000	1.929	20.8	7.7	25.4	49.0	100
CONE 02231-B	black	0.866	0.317	1.220	2.087	22.0	8.1	31.0	53.0	100

# CONS

## Silicone Cone Caps

Heat resistant up to 600°F (315°C)

Material: Silicone

Duro: 65 +/- 5 Shore

Part number	Color	MJD (in)	MND (in)	WD (in)	L (in)	MJD (mm)	MND (mm)	WD (mm)	L (mm)	pcs/bag
CONS 00613-C	clear	0.250	0.071	0.500	0.906	6.4	1.8	12.7	23.0	500
CONS 00813-F	rusty	0.316	0.099	0.500	1.000	8.0	2.5	12.7	25.4	500
CONS 00916-L	yellow	0.335	0.111	0.625	1.000	8.5	2.8	15.9	25.4	500
CONS 01017-Z	grown	0.394	0.137	0.650	1.102	10.0	3.5	16.5	28.0	500
CONS 01116-C	clear	0.400	0.139	0.635	1.100	10.2	3.5	16.1	27.9	250
CONS 01419-B	black	0.551	0.199	0.750	1.417	14.0	5.1	19.1	36.0	250
CONS 01725-G	green	0.689	0.266	0.980	1.500	17.5	6.8	24.9	38.1	250
CONS 02028-U	blue	0.767	0.270	1.100	2.009	19.5	6.9	27.9	51.0	100
CONS 02125-R	red	0.819	0.304	1.000	1.929	20.8	7.7	25.4	49.0	100
CONS 02231-P	purple	0.866	0.317	1.220	2.087	22.0	8.1	31.0	53.0	100

Current pricing and additional sizes available at [www.epsi.com](http://www.epsi.com)

Not all sizes are available in all warehouse locations - please check with your local sales rep for lead time and availability



# FSC



## Flat Silicone Caps

Heat resistant up to 600°F (315°C)

Material: Silicone

Duro: 55 +/- 5 Shore

- » Alternative to many Silicone Cap (SC) sizes
- » When sizing parts as a cap, the ID of the cap should be 2-5% smaller than the stud diameter
- » Reduces creepage in applications where temperature changes rapidly
- » Flexible enough to conform to irregular geometry
- » Flat top aids application and minimizes air trap
- » Flat Silicone Caps are reusable and will not melt or harden

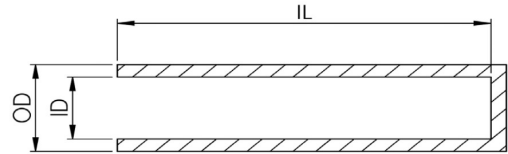

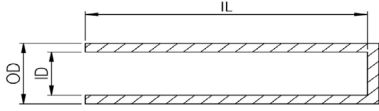

# FSC

Part number	Color	ID (in)	OD (in)	IL (in)	ID (mm)	OD (mm)	IL (mm)	pcs/bag
FSC 0070X1000-F	rusty	0.070	0.190	1.000	1.8	4.8	25.4	1000
FSC 0100X1000-F	rusty	0.100	0.220	1.000	2.5	5.6	25.4	1000
FSC 0100X1120-C	clear	0.100	0.220	1.120	2.5	5.6	28.4	1000
FSC 0120X0400-C	clear	0.120	0.240	0.400	3.0	6.1	10.1	1000
FSC 0148X1000-F	rusty	0.148	0.268	1.000	3.8	6.8	25.4	1000
FSC 0175X1000-F	rusty	0.175	0.295	1.000	4.4	7.5	25.4	1000
FSC 0223X1500-F	rusty	0.223	0.343	1.500	5.7	8.7	38.1	1000
FSC 0355X1500-F	rusty	0.355	0.475	1.500	9.0	12.1	38.1	500
FSC 0375X1500-F	rusty	0.375	0.495	1.500	9.5	12.6	38.1	500
FSC 0456X1500-F	rusty	0.456	0.576	1.500	11.6	14.6	38.1	500
FSC 0515X0728-C	clear	0.515	0.635	0.728	13.1	16.1	18.5	250
FSC 0535X1500-F	rusty	0.535	0.655	1.500	13.6	16.6	38.1	250
FSC 0600X1500-F	rusty	0.600	0.720	1.500	15.2	18.3	38.1	250
FSC 0640X2000-B	black	0.640	0.760	2.000	16.3	19.3	50.8	250
FSC 0730X1500-F	rusty	0.730	0.850	1.500	18.5	21.6	38.1	250
FSC 0736X0728-C	clear	0.736	0.856	0.728	18.7	21.7	18.5	250
FSC 0855X1500-F	rusty	0.855	0.975	1.500	21.7	24.8	38.1	250
FSC 0980X1500-F	rusty	0.980	1.100	1.500	24.9	27.9	38.1	250
FSC 1106X0905-C	clear	1.106	1.226	0.905	28.1	31.1	23.0	250
FSC 1291X0905-C	clear	1.291	1.449	0.905	32.8	36.8	23.0	100
FSC 1555X1102-C	clear	1.555	1.675	1.102	39.5	42.5	28.0	100
FSC 1772X0670-R	red	1.772	2.126	0.670	45.0	54.0	17.0	100
FSC 1850X1102-C	clear	1.850	1.970	1.102	47.0	50.0	28.0	100

Current pricing and additional sizes available at [www.epsi.com](http://www.epsi.com)

Not all sizes are available in all warehouse locations - please check with your local sales rep for lead time and availability



# FCS



## Flanged Silicone Caps

Heat resistant up to 600°F (315°C)

Material: Silicone

Duro: 55 +/- 5 Shore

- » Alternative to many Silicone Cap (SC) sizes
- » Flange makes removal easier
- » Can be flipped upside down and inserted into threaded holes to mask chamfers and countersinks
- » When sizing parts as a cap, the ID of the cap should be 2-5% smaller than the stud diameter

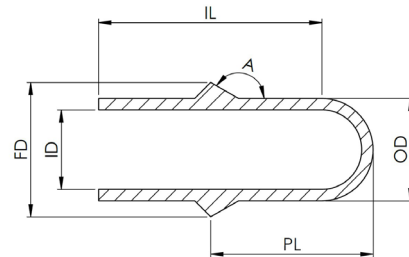

Part number	Color	ID (in)	OD (in)	FD (in)	IL (in)	PL (in)	A	ID (mm)	OD (mm)	FD (mm)	IL (mm)	PL (mm)	pcs/bag
FCS 012031-L	yellow	0.173	0.291	0.472	0.748	0.472	150°	4.4	7.4	12.0	19.0	12.0	250
FCS 015032-N	pink	0.224	0.343	0.579	0.748	0.579	150°	5.7	8.7	14.7	19.0	14.7	250
FCS 016033-C	clear	0.303	0.421	0.622	0.748	0.622	150°	7.7	10.7	15.8	19.0	15.8	250
FCS 018034-Y	grey	0.421	0.539	0.709	0.748	0.709	150°	10.7	13.7	18.0	19.0	18.0	250

Current pricing and additional sizes available at [www.epsi.com](http://www.epsi.com)

Not all sizes are available in all warehouse locations - please check with your local sales rep for lead time and availability



## Multi Length Caps

Heat resistant up to 600°F (315°C)

Material: Silicone

Duro: 55 +/- 5 Shore

- » Convenient: They reduce inventory and require less logistics due to one cap covering a multitude of stud and threaded stud lengths
- » Durable: Made of durable, high temperature resistant silicone for repeated use
- » Versatile: Each cap can replace between two and four standard silicone caps from the EPSI catalog
- » Innovative: Installation & removal of the caps are facilitated by a generous handle
- » When sizing as a cap, ID should be 5-7% smaller than stud

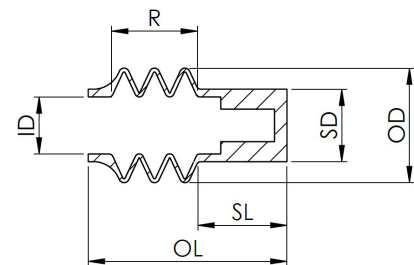

Part number	Color	ID (in)	R min (in)	R max (in)	OL (in)	SL (in)	SD (in)	OD (in)	ID (mm)	R min (mm)	R max (mm)	OL (mm)	SL (mm)	SD (mm)	OD (mm)	pcs/bag
MLC 0234X1500-SP	purple	0.234	0.50	1.50	1.593	0.691	0.359	0.776	12.7	38.1	44.45	40.46	17.55	9.12	31.75	200
MLC 0295X1500-SR	red	0.295	0.50	1.50	1.593	0.691	0.420	0.837	19.05	57.15	66.68	40.46	17.55	10.67	44.45	150
MLC 0406X1500-SL	orange	0.340	1.00	2.00	1.593	0.691	0.535	0.882	34.93	101.6	119.08	40.46	17.55	13.59	88.9	100
MLC 0406X1500-SL	yellow	0.406	1.00	1.50	1.593	0.691	0.531	0.869	76.2	177.8	215.9	40.46	17.55	13.49	184.15	100
MLC 0456X1500-SG	green	0.456	0.50	1.50	1.593	0.691	0.581	0.919	171.45	177.8	263.53	40.46	17.55	14.76	431.8	100

Current pricing and additional sizes available at [www.epsi.com](http://www.epsi.com)

Not all sizes are available in all warehouse locations - please check with your local sales rep for lead time and availability

# EZY



## Easy Caps

Heat resistant up to 600°F (315°C)

Material: Silicone

Duro: 55 +/- 5 Shore

- » If internal pressure is causing blow-offs, place a slit in or remove the nipple. This will allow for venting of internal pressure (Not recommended for immersion coatings)
- » Due to the internal ring, a much smaller ID can be used compared to a standard cap
- » Size at least 10% less than the stud OD
- » EZY™ Caps are ideal for large diameter or long length products
- » Specially designed internal ring allows for easy placement and a liquid-tight seal
- » Oversized head for easy removal
- » Many sizes available with built-in air-vent to eliminate the effects of pressure build-up
- » EZY™ Caps are reusable and will not melt or harden
- » EZY™ Caps offer fine line masking

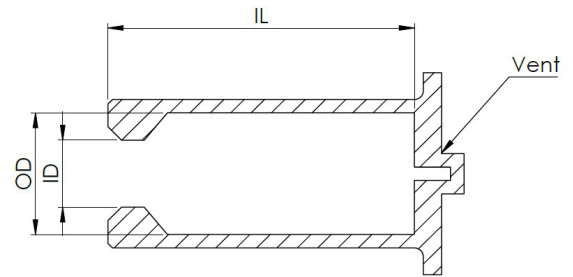



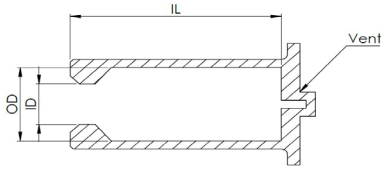

# EZY

Part number	Color	ID (in)	OD (in)	IL (in)	ID (mm)	OD (mm)	IL (mm)	pcs/bag
EZY 0102X0813-R	red	0.102	0.260	0.813	2.6	6.6	20.7	500
EZY 0126X0813-O	orange	0.126	0.386	0.813	3.2	9.8	20.7	500
EZY 0143X1063-L	yellow	0.143	0.386	1.063	3.6	9.8	27.0	500
EZY 0173X1563-U	blue	0.173	0.451	1.563	4.4	11.5	39.7	500
EZY 0187X1377-F	rusty	0.187	0.427	1.377	4.7	10.8	35.0	500
EZY 0294X1330-F	rusty	0.294	0.534	1.330	7.5	13.6	33.8	250
EZY 0288X1563-B	black	0.288	0.515	1.563	7.3	13.1	39.7	250
EZY 0294X1330-F	rusty	0.294	0.534	1.330	7.5	13.6	33.8	250
EZY 0349X1563-W	white	0.349	0.579	1.563	8.9	14.7	39.7	250
EZY 0375X1421-F	rusty	0.375	0.615	1.421	9.5	15.6	36.1	250
EZY 0407X1250-R	red	0.407	0.640	1.250	10.3	16.3	31.8	250
EZY 0433X1180-F	rusty	0.433	0.673	1.180	11.0	17.1	30.0	250
EZY 0456X2000-F	rusty	0.456	0.732	2.000	11.6	18.6	50.8	250
EZY 0518X2063-O	orange	0.518	0.769	2.063	13.2	19.5	52.4	50
EZY 0529X1563-L	yellow	0.529	0.708	1.563	13.4	18.0	39.7	100
EZY 0588X2563-G	green	0.588	0.833	2.563	14.9	21.2	65.1	50
EZY 0665X1563-P	purple	0.665	0.896	1.563	16.9	22.8	39.7	100
EZY 0687X1180-F	rusty	0.687	0.977	1.180	17.4	24.8	30.0	100
EZY 0823X1563-B	black	0.823	1.020	1.563	20.9	25.9	39.7	50
EZY 0898X1563-W	white	0.898	1.085	1.563	22.8	27.6	39.7	50
EZY 0906X3500-F	rusty	0.906	1.146	3.500	23.0	29.1	88.9	50
EZY 1080X1563-R	red	1.080	1.280	1.563	27.4	32.5	39.7	50
EZY 1125X5000-F	rusty	1.125	1.365	5.000	28.6	34.7	127.0	50
EZY 1134X1563-O	orange	1.134	1.338	1.563	28.8	34.0	39.7	50
EZY 1247X1563-L	yellow	1.247	1.459	1.563	31.7	37.1	39.7	50
EZY 1288X2500-F	rusty	1.288	1.528	2.500	32.7	38.8	63.5	50
EZY 1375X2063-G	green	1.375	1.585	2.063	34.9	40.3	52.4	50
EZY 1455X2063-U	blue	1.455	1.650	2.063	37.0	41.9	52.4	50
EZY 2250X1920-F	rusty	2.250	2.490	1.920	57.2	63.2	48.8	25
EZY 2500X2420-F	rusty	2.500	2.740	2.420	63.5	69.6	61.5	25
EZY 2750X2670-F	rusty	2.750	2.990	2.670	69.9	75.9	67.8	25
EZY 3000X2920	clear	3.000	3.240	2.920	76.2	82.3	74.2	25

Current pricing and additional sizes available at [www.epsi.com](http://www.epsi.com)

Not all sizes are available in all warehouse locations - please check with your local sales rep for lead time and availability



# MBM



## Multi Balloon Masking

Heat resistant up to 600°F (315°C)

Material: Silicone

Duro: 20 +/- 5 Shore

- » Features an incredible stretch rate – 150%! So many shapes and sizes can be masked with only one MBM
- » Five balloon masks replace 30+ standard silicone caps
- » b. The five balloon masks collectively stretch from 12.7 mm to 431.9 mm
- » Convenient: Easy to use – just slip it over a part
- » Durable: Made of thin, soft, high temperature resistant silicone
- » Innovative: During the hot curing process, the balloon masks will inflate before they pop off the part being masked
- » Perfect Fit: The bead molded into the bottom of each cap allows for a tighter fit around the part being masked
- » Fast & Easy: Very effective for relatively larger parts that aren't necessarily round
- » Undersize 10-15% to start
- » Roll it up for easier application and removal

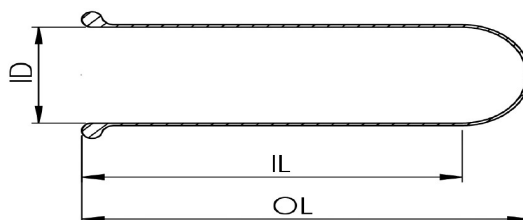

Part number	Color	ID (in)	IL (in)	OL (in)	ID MAX* (in)	ID (mm)	IL (mm)	OL (mm)	ID MAX* (mm)	pcs/bag
MBM 0500X1500-SR	red	0.500	1.500	1.750	1.25	12.7	38.1	44.45	31.75	150
MBM 0750X2250-SO	orange	0.750	2.250	2.625	1.75	19.05	57.15	66.68	44.45	100
MBM 1375X4000-SL	yellow	1.375	4.000	4.688	3.50	34.93	101.6	119.08	88.9	20
MBM 3000X7000-SG	green	3.000	7.000	8.500	7.25	76.2	177.8	215.9	184.15	10
MBM 6750X7000-SU	blue	6.750	7.000	10.375	17.00	171.45	177.8	263.53	431.8	5

# REC



## Rectangular Caps

Heat resistant up to 600°F (315°C)

Material: Silicone

Duro: 55 +/- 5 Shore

- » Used as a cap over connectors and rectangular extensions
- » When sizing, make sure the inner length and width are under-sized for a tight fit

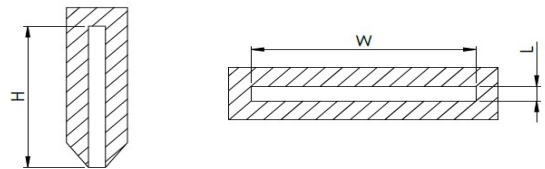

Part number	Color	W (in)	L (in)	H (in)	W (mm)	L (mm)	H (mm)	pcs/bag
REC 0130	orange	0.130	0.059	0.209	3.3	1.5	5.3	1000
REC 0236	grey	0.236	0.059	0.433	6.0	1.5	11.0	1000
REC 0247	clear	0.247	0.030	0.376	6.3	0.8	9.6	1000
REC 0248	pink	0.248	0.030	0.456	6.3	0.8	11.6	1000
REC 0460	yellow	0.460	0.035	0.280	11.7	0.9	7.1	1000
REC 0470	green	0.470	0.040	0.374	11.9	1.0	9.5	1000
REC 0490	purple	0.490	0.047	0.687	12.4	1.2	17.4	500
REC 0875	grey	0.875	0.090	1.500	22.2	2.3	38.1	250

Current pricing and additional sizes available at [www.epsi.com](http://www.epsi.com)

Not all sizes are available in all warehouse locations - please check with your local sales rep for lead time and availability

# Custom Masking



Are you spending too much on masking labor?  
Is your line speed suffering due to complicated masking?  
Do you want to reduce your 3P cost (per painted part)?  
If so, custom masking from EPSI is for you!

EPSI is proud to offer custom silicone masks. Our in-house engineering team possesses over a decade of experience in partnering with clients towards the production of tens of thousands of custom silicone masks. We continually lead the industry in creating efficient, custom solutions that cater to diverse applications.

At EPSI, our custom silicone mask process commences by gathering all relevant data from the client, including drawings, samples, and any other pertinent information. Through a comprehensive consultation process, we discuss and determine the most suitable masking method to utilize. Our ultimate goal is to produce a final product that aligns with the client's precise requirements and specifications.

We believe that our proficient workforce, coupled with our extensive experience, enables us to consistently deliver quality custom silicone masks to our esteemed customers.

Go Custom with EPSI and SAVE!



# STS



## Silicone Tapered Stoppers

Heat resistant up to 600°F (315°C)

Material: Silicone

Duro: 55 +/- 5 Shore

- » For the best fit, match the hole diameter to the plug midpoint diameter
- » Silicone Tapered Stoppers are not recommended for exposure to aggressive chemicals or hydrocarbons
- » Tapered design to fit a variety of hole diameters
- » Compressible for better sealing of both threaded and non-threaded holes

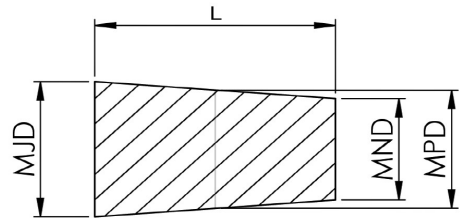

Part number	Color	MJD (in)	MND (in)	MPD (in)	L (in)	MJD (mm)	MND (mm)	MPD (mm)	L (mm)	pcs/bag
STS 0062-B	black	0.062	0.016	0.039	0.625	1.6	0.4	1.0	15.9	1000
STS 0078X1000-U	blue	0.078	0.020	0.049	1.000	2.0	0.5	1.2	25.4	1000
STS 0100X0625-L	yellow	0.100	0.031	0.066	0.625	2.5	0.8	1.7	15.9	1000
STS 0100X1000-L	yellow	0.100	0.031	0.066	1.000	2.5	0.8	1.7	25.4	1000
STS 0125-N	pink	0.125	0.062	0.094	0.625	3.2	1.6	2.4	15.9	1000
STS 0177X0591-P	purple	0.177	0.060	0.119	0.591	4.5	1.5	3.0	15.0	1000
STS 0187X0394	clear	0.187	0.109	0.148	0.394	4.7	2.8	3.8	10.0	1000

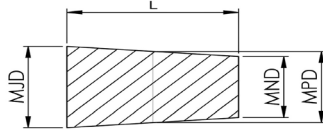

# STS

Part number	Color	MJD (in)	MND (in)	MPD (in)	L (in)	MJD (mm)	MND (mm)	MPD (mm)	L (mm)	pcs/bag
STS 0187X0625-W	white	0.187	0.062	0.125	0.625	4.7	1.6	3.2	15.9	1000
STS 0187X0750-F	rusty	0.187	0.062	0.125	0.750	4.7	1.6	3.2	19.1	1000
STS 0188X2200-Y	grey	0.188	0.047	0.118	2.200	4.8	1.2	3.0	55.9	1000
STS 0197-G	green	0.197	0.049	0.123	1.100	5.0	1.2	3.1	27.9	1000
STS 0200-U	blue	0.200	0.062	0.131	0.750	5.1	1.6	3.3	19.1	1000
STS 0216-N	pink	0.216	0.047	0.132	1.500	5.5	1.2	3.3	38.1	1000
STS 0250X0750-G	green	0.250	0.125	0.188	0.750	6.4	3.2	4.8	19.1	1000
STS 0250X1000-F	rusty	0.250	0.125	0.188	1.000	6.4	3.2	4.8	25.4	1000
STS 0276X0787-L	yellow	0.276	0.118	0.197	0.787	7.0	3.0	5.0	20.0	1000
STS 0315X0787-R	red	0.315	0.157	0.236	0.787	8.0	4.0	6.0	20.0	1000
STS 0343X0625-U	blue	0.343	0.187	0.265	0.625	8.7	4.7	6.7	15.9	1000
STS 0343X1000-F	rusty	0.343	0.187	0.265	1.000	8.7	4.7	6.7	25.4	1000
STS 0354X0984-I	ivory	0.354	0.177	0.266	0.984	9.0	4.5	6.7	25.0	1000
STS 0375X0500-L	yellow	0.375	0.250	0.313	0.500	9.5	6.4	7.9	12.7	500
STS 0375X0750-L	yellow	0.375	0.250	0.313	0.750	9.5	6.4	7.9	19.1	500
STS 0375X1250-L	yellow	0.375	0.125	0.250	1.250	9.5	3.2	6.4	31.8	500
STS 0393-U	blue	0.393	0.236	0.315	0.787	10.0	6.0	8.0	20.0	500
STS 0394-W	white	0.394	0.197	0.296	1.890	10.0	5.0	7.5	48.0	500
STS 0433X1063-G	green	0.433	0.315	0.374	1.063	11.0	8.0	9.5	27.0	500
STS 0437-F	rusty	0.437	0.250	0.344	1.000	11.1	6.4	8.7	25.4	500
STS 0438-B	black	0.438	0.344	0.391	0.688	11.1	8.7	9.9	17.5	500
STS 0472-R	red	0.472	0.354	0.413	0.748	12.0	9.0	10.5	19.0	500
STS 0473X0787-Y	grey	0.473	0.312	0.393	0.787	12.0	7.9	10.0	20.0	500
STS 0487	clear	0.487	0.354	0.421	0.748	12.4	9.0	10.7	19.0	500
STS 0500X0813-Z	brown	0.500	0.313	0.407	0.813	12.7	8.0	10.3	20.7	250
STS 0500X1000-Z	brown	0.500	0.312	0.406	1.000	12.7	7.9	10.3	25.4	250
STS 0500X2000-Z	brown	0.500	0.125	0.313	2.000	12.7	3.2	7.9	50.8	250
STS 0512X0984-B	black	0.512	0.354	0.433	0.984	13.0	9.0	11.0	25.0	250
STS 0562-F	rusty	0.562	0.313	0.438	1.125	14.3	8.0	11.1	28.6	250
STS 0563-U	blue	0.563	0.375	0.469	1.000	14.3	9.5	11.9	25.4	250
STS 0590-P	purple	0.590	0.393	0.492	1.000	15.0	10.0	12.5	25.4	250
STS 0591-Z	brown	0.591	0.433	0.512	0.787	15.0	11.0	13.0	20.0	250
STS 0625-G	green	0.625	0.437	0.531	0.813	15.9	11.1	13.5	20.7	250
STS 0656	clear	0.656	0.500	0.578	1.000	16.7	12.7	14.7	25.4	250
STS 0669-R	red	0.669	0.510	0.590	1.000	17.0	13.0	15.0	25.4	250
STS 0687	clear	0.687	0.437	0.562	1.000	17.4	11.1	14.3	25.4	250
STS 0709X0787	clear	0.709	0.551	0.630	0.787	18.0	14.0	16.0	20.0	250
STS 0748-B	black	0.748	0.550	0.649	1.000	19.0	14.0	16.5	25.4	250
STS 0787-R	red	0.787	0.630	0.709	1.000	20.0	16.0	18.0	25.4	100

# STS

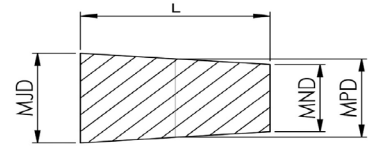

Part number	Color	MJD (in)	MND (in)	MPD (in)	L (in)	MJD (mm)	MND (mm)	MPD (mm)	L (mm)	pcs/bag
STS 0812	clear	0.812	0.625	0.719	1.000	20.6	15.9	18.2	25.4	100
STS 0827X0984-R	red	0.827	0.630	0.729	0.984	21.0	16.0	18.5	25.0	100
STS 0925	clear	0.925	0.750	0.838	1.000	23.5	19.1	21.3	25.4	100
STS 0938-L	yellow	0.938	0.708	0.823	1.000	23.8	18.0	20.9	25.4	100
STS 0945-B	black	0.945	0.756	0.851	0.750	24.0	19.2	21.6	19.1	100
STS 0946	clear	0.946	0.709	0.828	1.181	24.0	18.0	21.0	30.0	100
STS 0984X0885	clear	0.984	0.787	0.886	0.885	25.0	20.0	22.5	22.5	100
STS 0990	clear	0.990	0.880	0.935	0.795	25.1	22.4	23.7	20.2	100
STS 1024	clear	1.024	0.787	0.906	1.000	26.0	20.0	23.0	25.4	100
STS 1062X0984	clear	1.062	0.866	0.964	0.984	27.0	22.0	24.5	25.0	100
STS 1063	clear	1.063	0.905	0.984	1.000	27.0	23.0	25.0	25.4	100
STS 1102X1000	clear	1.102	0.945	1.024	1.000	28.0	24.0	26.0	25.4	100
STS 1102X2000	clear	1.102	0.750	0.926	2.000	28.0	19.1	23.5	50.8	100
STS 1220X1181	clear	1.220	0.984	1.102	1.181	31.0	25.0	28.0	30.0	100
STS 1260	clear	1.260	1.024	1.142	1.000	32.0	26.0	29.0	25.4	100
STS 1325X0835	clear	1.325	1.140	1.233	0.835	33.7	29.0	31.3	21.2	100
STS 1338	clear	1.338	1.063	1.201	1.000	34.0	27.0	30.5	25.4	100
STS 1375	clear	1.375	1.180	1.278	1.000	34.9	30.0	32.4	25.4	100
STS 1456	clear	1.456	1.180	1.318	1.000	37.0	30.0	33.5	25.4	100
STS 1535	clear	1.535	1.220	1.378	1.000	39.0	31.0	35.0	25.4	50
STS 1614	clear	1.614	1.300	1.457	1.000	41.0	33.0	37.0	25.4	50
STS 1693	clear	1.693	1.417	1.555	1.000	43.0	36.0	39.5	25.4	50
STS 1732X1575	clear	1.732	1.417	1.575	1.575	44.0	36.0	40.0	40.0	50
STS 1772	clear	1.772	1.457	1.615	1.000	45.0	37.0	41.0	25.4	50
STS 1810	clear	1.810	1.496	1.653	1.000	46.0	38.0	42.0	25.4	50
STS 1968	clear	1.968	1.653	1.811	1.000	50.0	42.0	46.0	25.4	50
STS 2086	clear	2.086	1.770	1.928	1.000	53.0	45.0	49.0	25.4	25
STS 2205	clear	2.205	1.890	2.048	1.000	56.0	48.0	52.0	25.4	25
STS 2362X1772	clear	2.362	1.969	2.166	1.772	60.0	50.0	55.0	45.0	25
STS 2480	clear	2.480	1.968	2.224	1.000	63.0	50.0	56.5	25.4	25
STS 2520	clear	2.520	2.125	2.323	1.000	64.0	54.0	59.0	25.4	25
STS 2677	clear	2.677	2.283	2.480	1.000	68.0	58.0	63.0	25.4	25
STS 2953	clear	2.953	2.440	2.697	1.377	75.0	62.0	68.5	35.0	25
STS 3543	clear	3.543	2.953	3.248	1.535	90.0	75.0	82.5	39.0	10
STS 4055X1535	clear	4.055	3.267	3.661	1.535	103.0	83.0	93.0	39.0	10
STS 5000	clear	5.000	3.543	4.272	1.968	127.0	90.0	108.5	50.0	5

Current pricing and additional sizes available at [www.epsi.com](http://www.epsi.com)

Not all sizes are available in all warehouse locations - please check with your local sales rep for lead time and availability





# HSTS



## Hollow Silicone Tapered Stoppers

Heat resistant up to 600°F (315°C)

Material: Silicone

Duro: 55 +/- 5 Shore

- » Reusable and will not melt or harden
- » Fits hole diameters from 25.0 mm to 120.0 mm
- » For the best fit, match the hole diameter to the plug midpoint diameter
- » Hollow core offers increased compressibility

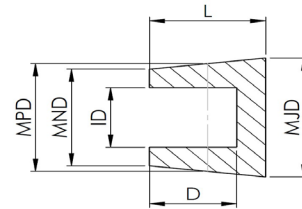

Part number	Color	ID (in)	MJD (in)	MND (in)	MPD (in)	D (in)	L (in)	ID (mm)	MJD (mm)	MND (mm)	MPD (mm)	D (mm)	L (mm)	pcs/bag
HSTS 1063-W	white	0.500	1.063	0.905	0.984	0.750	1.000	12.7	27.0	23.0	25.0	19.1	25.4	100
HSTS 1102-F	rusty	0.500	1.102	0.945	1.024	0.750	1.000	12.7	28.0	24.0	26.0	19.1	25.4	100
HSTS 1260-L	yellow	0.610	1.260	1.024	1.142	0.750	1.000	15.5	32.0	26.0	29.0	19.1	25.4	100
HSTS 1338-Z	brown	0.750	1.338	1.063	1.201	0.750	1.000	19.1	34.0	27.0	30.5	19.1	25.4	100
HSTS 1456-U	blue	0.625	1.456	1.180	1.318	0.710	1.000	15.9	37.0	30.0	33.5	18.0	25.4	100
HSTS 1535-B	black	0.660	1.535	1.220	1.378	0.710	1.000	16.8	39.0	31.0	35.0	18.0	25.4	50
HSTS 1614-R	red	0.700	1.614	1.300	1.457	0.710	1.000	17.8	41.0	33.0	37.0	18.0	25.4	50
HSTS 1693-Y	grey	0.750	1.693	1.417	1.555	0.700	1.000	19.1	43.0	36.0	39.5	17.8	25.4	50
HSTS 1772-N	pink	0.788	1.772	1.457	1.615	0.715	1.000	20.0	45.0	37.0	41.0	18.2	25.4	50
HSTS 1810-W	white	0.821	1.810	1.496	1.653	0.718	1.000	20.9	46.0	38.0	42.0	18.2	25.4	50
HSTS 1968-F	rusty	0.980	1.968	1.653	1.811	0.722	1.000	24.9	50.0	42.0	46.0	18.3	25.4	50
HSTS 2086-G	green	1.100	2.086	1.770	1.928	0.723	1.000	27.9	53.0	45.0	49.0	18.4	25.4	25
HSTS 2205-L	yellow	1.220	2.205	1.890	2.048	0.723	1.000	31.0	56.0	48.0	52.0	18.4	25.4	25
HSTS 2480-Z	brown	1.285	2.480	1.968	2.224	0.718	1.000	32.6	63.0	50.0	56.5	18.2	25.4	25
HSTS 2520-U	blue	1.465	2.520	2.125	2.323	0.720	1.000	37.2	64.0	54.0	59.0	18.3	25.4	25
HSTS 2677-F	rusty	1.578	2.677	2.283	2.480	0.719	1.000	40.1	68.0	58.0	63.0	18.3	25.4	25
HSTS 2953-R	red	1.800	2.953	2.440	2.697	1.000	1.377	45.7	75.0	62.0	68.5	25.4	35.0	25
HSTS 3543-Y	grey	2.256	3.543	2.953	3.248	1.200	1.535	57.3	90.0	75.0	82.5	30.5	39.0	10
HSTS 4055-N	pink	2.568	4.055	3.267	3.661	1.275	1.535	65.2	103.0	83.0	93.0	32.4	39.0	10
HSTS 4750	clear	2.625	4.750	3.543	4.147	2.250	3.423	66.7	120.7	90.0	105.3	57.2	86.9	5
HSTS 5000-W	white	2.760	5.000	3.543	4.272	1.584	1.968	70.1	127.0	90.0	108.5	40.2	50.0	5

Current pricing and additional sizes available at [www.epsi.com](http://www.epsi.com)

Not all sizes are available in all warehouse locations - please check with your local sales rep for lead time and availability



# STSH



## Silicone Tapered Stoppers with Handle

Heat resistant up to 600°F (315°C)

Material: Silicone

Duro: 55 +/- 5 Shore

- » For the best fit, match the hole diameter to the plug midpoint diameter
- » Silicone Tapered Stoppers with Handles are not recommended for exposure to aggressive chemicals or hydrocarbons
- » Tapered design to fit a variety of hole diameters
- » Compressible for better sealing of both threaded and non-threaded holes

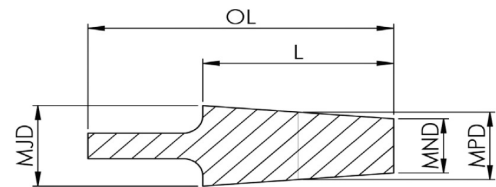

Part number	Color	MJD (in)	MND (in)	MPD (in)	L (in)	OL (in)	MJD (mm)	MND (mm)	MPD (mm)	L (mm)	OL (mm)	pcs/bag
STSH 0190X0063	pink	0.190	0.063	0.126	0.620	1.076	4.8	1.6	3.2	15.7	27.3	1000
STSH 0125X0625-L	yellow	0.125	0.063	0.094	0.625	1.081	3.2	1.6	2.4	15.9	27.5	1000
STSH 0200X0750-P	purple	0.200	0.100	0.150	0.750	1.206	5.1	2.5	3.8	19.1	30.6	1000
STSH 0250X0750	black	0.250	0.125	0.188	0.750	1.206	6.4	3.2	4.8	19.1	30.6	1000
STSH 0276X0787-W	white	0.276	0.138	0.207	0.787	1.287	7.0	3.5	5.3	20.0	32.7	1000
STSH 0331X0654	red	0.331	0.171	0.251	0.654	1.110	8.4	4.3	6.4	16.6	28.2	1000
STSH 0375X0750	yellow	0.375	0.250	0.313	0.750	1.206	9.5	6.4	7.9	19.1	30.6	100
STSH 0379X0500	white	0.379	0.250	0.315	0.500	0.956	9.6	6.4	8.0	12.7	24.3	100
STSH 0438X0668	green	0.438	0.219	0.329	0.668	1.168	11.1	5.6	8.3	17.0	29.7	500
STSH 0472X0748	blue	0.742	0.236	0.489	0.748	1.248	18.8	6.0	12.4	19.0	31.7	500
STSH 0594X1000	yellow	0.594	0.297	0.446	1.000	1.500	15.1	7.5	11.3	25.4	38.1	250
STSH 0625X0875	purple	0.625	0.313	0.469	0.875	1.375	15.9	7.9	11.9	22.2	34.9	250
STSH 0500X2000	purple	0.500	0.250	0.375	2.000	2.500	12.7	6.4	9.5	50.8	63.5	250
STSH 0656X1000	purple	0.656	0.500	0.578	1.000	1.456	16.7	12.7	14.7	25.4	37.0	100
STSH 0781X1000	white	0.781	0.391	0.586	1.000	1.500	19.8	9.9	14.9	25.4	38.1	100
STSH 0938X1000	red	0.938	0.469	0.704	1.000	1.675	23.8	11.9	17.9	25.4	42.5	100
STSH 1000X1000	green	1.000	0.500	0.750	1.000	1.675	25.4	12.7	19.1	25.4	42.5	100
STSH 1024X1000	blue	1.024	0.512	0.768	1.000	1.675	26.0	13.0	19.5	25.4	42.5	100

# CRKR



## Cork Stoppers

Heat resistant up to 300°F (150°C)

Material: Cork

- » Cork Stoppers can be easily trimmed for shallow cavities
- » Select a stopper whose midpoint diameter is closest to the diameter of the hole you are plugging
- » Ideal for wet paint and low-temp powder coating applications
- » Useful when it is necessary to leave a plug in for shipping

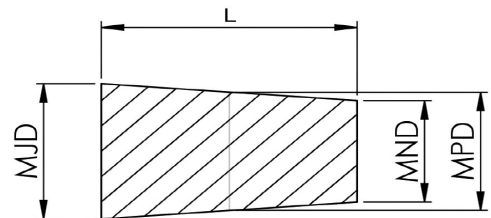

Part number	MJD (in)	MND (in)	MPD (in)	L (in)	MJD (mm)	MND (mm)	MPD (mm)	L (mm)	pcs/bag
CRKR 0189	0.189	0.094	0.142	0.500	4.8	2.4	3.6	12.7	1000
CRKR 0248	0.248	0.157	0.203	0.500	6.3	4.0	5.1	12.7	1000
CRKR 0311	0.311	0.217	0.264	0.500	7.9	5.5	6.7	12.7	1000
CRKR 0374	0.374	0.280	0.327	0.500	9.5	7.1	8.3	12.7	1000
CRKR 0437	0.437	0.327	0.382	0.626	11.1	8.3	9.7	15.9	500
CRKR 0500	0.500	0.378	0.439	0.689	12.7	9.6	11.2	17.5	250
CRKR 0563	0.563	0.436	0.500	0.748	14.3	11.1	12.7	19.0	250
CRKR 0626	0.626	0.469	0.548	0.811	15.9	11.9	13.9	20.6	250
CRKR 0689	0.689	0.531	0.610	0.874	17.5	13.5	15.5	22.2	250
CRKR 0748	0.748	0.579	0.664	0.937	19.0	14.7	16.9	23.8	100
CRKR 0799	0.799	0.626	0.713	1.000	20.3	15.9	18.1	25.4	100
CRKR 0874	0.874	0.673	0.774	1.063	22.2	17.1	19.6	27.0	100
CRKR 0937	0.937	0.732	0.835	1.126	23.8	18.6	21.2	28.6	100
CRKR 1000	1.000	0.764	0.882	1.252	25.4	19.4	22.4	31.8	100

Current pricing and additional sizes available at [www.epsi.com](http://www.epsi.com)

Not all sizes are available in all warehouse locations - please check with your local sales rep for lead time and availability

# BES



## Black EPDM Stoppers

Heat resistant up to 475°F (250°C)

Material: EPDM

Duro: 55 +/- 5 Shore

- » For the best fit, match the hole diameter to the plug midpoint diameter
- » Black EPDM Stoppers are not recommended for prolonged exposure to intense heat
- » Tapered to fit a variety of hole diameters
- » Compressible for better sealing of both threaded and non-threaded holes
- » Ideal for sand blasting
- » Excellent chemical and hydrocarbon resistance

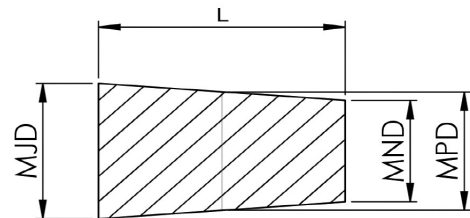

Part number	Color	MJD (in)	MND (in)	MPD (in)	L (in)	MJD (mm)	MND (mm)	MPD (mm)	L (mm)	pcs/bag
BES 0100X0625	black	0.100	0.031	0.066	0.625	2.5	0.8	1.7	15.9	1000
BES 0125	black	0.125	0.062	0.094	0.625	3.2	1.6	2.4	15.9	1000
BES 0187X0625	black	0.187	0.062	0.125	0.625	4.7	1.6	3.2	15.9	1000
BES 0187X0750	black	0.187	0.062	0.125	0.750	4.7	1.6	3.2	19.1	1000
BES 0197	black	0.197	0.049	0.123	1.100	5.0	1.2	3.1	27.9	1000
BES 0200	black	0.200	0.062	0.131	0.750	5.1	1.6	3.3	19.1	1000
BES 0216	black	0.216	0.047	0.132	1.500	5.5	1.2	3.3	38.1	1000
BES 0250X0750	black	0.250	0.125	0.188	0.750	6.4	3.2	4.8	19.1	1000
BES 0250X1000	black	0.250	0.125	0.188	1.000	6.4	3.2	4.8	25.4	1000
BES 0343X0625	black	0.343	0.187	0.265	0.625	8.7	4.7	6.7	15.9	1000
BES 0343X1000	black	0.343	0.187	0.265	1.000	8.7	4.7	6.7	25.4	1000

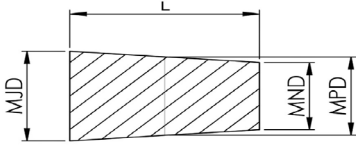

# BES

Part number	Color	MJD (in)	MND (in)	MPD (in)	L (in)	MJD (mm)	MND (mm)	MPD (mm)	L (mm)	pcs/bag
BES 0375X0500	black	0.375	0.250	0.313	0.500	9.5	6.4	7.9	12.7	500
BES 0375X0750	black	0.375	0.250	0.313	0.750	9.5	6.4	7.9	19.1	500
BES 0375X1250	black	0.375	0.125	0.250	1.250	9.5	3.2	6.4	31.8	500
BES 0394	black	0.394	0.197	0.296	1.890	10.0	5.0	7.5	48.0	500
BES 0437	black	0.437	0.250	0.344	1.000	11.1	6.4	8.7	25.4	500
BES 0438	black	0.438	0.344	0.391	0.688	11.1	8.7	9.9	17.5	500
BES 0500X0813	black	0.500	0.313	0.407	0.813	12.7	8.0	10.3	20.7	250
BES 0500X1000	black	0.500	0.312	0.406	1.000	12.7	7.9	10.3	25.4	250
BES 0563	black	0.563	0.375	0.469	1.000	14.3	9.5	11.9	25.4	250
BES 0590	black	0.590	0.393	0.492	1.000	15.0	10.0	12.5	25.4	250
BES 0625	black	0.625	0.437	0.531	0.813	15.9	11.1	13.5	20.7	250
BES 0656	black	0.656	0.500	0.578	1.000	16.7	12.7	14.7	25.4	250
BES 0669	black	0.669	0.510	0.590	1.000	17.0	13.0	15.0	25.4	250
BES 0687	black	0.687	0.437	0.562	1.000	17.4	11.1	14.3	25.4	250
BES 0748	black	0.748	0.550	0.649	1.000	19.0	14.0	16.5	25.4	250
BES 0812	black	0.812	0.625	0.719	1.000	20.6	15.9	18.2	25.4	100
BES 0938	black	0.938	0.708	0.823	1.000	23.8	18.0	20.9	25.4	100
BES 1024	black	1.024	0.787	0.906	1.000	26.0	20.0	23.0	25.4	100
BES 1063	black	1.063	0.905	0.984	1.000	27.0	23.0	25.0	25.4	100
BES 1102X1000	black	1.102	0.945	1.024	1.000	28.0	24.0	26.0	30.0	100
BES 1220X1181	black	1.220	0.984	1.102	1.181	31.0	25.0	28.0	25.4	100
BES 1260	black	1.260	1.024	1.142	1.000	32.0	26.0	29.0	25.4	100
BES 1338	black	1.338	1.063	1.201	1.000	34.0	27.0	30.5	25.4	100
BES 1456	black	1.456	1.180	1.318	1.000	37.0	30.0	33.5	25.4	100
BES 1535	black	1.535	1.220	1.378	1.000	39.0	31.0	35.0	25.4	50
BES 1614	black	1.614	1.300	1.457	1.000	41.0	33.0	37.0	25.4	50
BES 1693	black	1.693	1.417	1.555	1.000	43.0	36.0	39.5	25.4	50
BES 1772	black	1.772	1.457	1.615	1.000	45.0	37.0	41.0	25.4	50
BES 1810	black	1.810	1.496	1.653	1.000	46.0	38.0	42.0	25.4	50
BES 1968	black	1.968	1.653	1.811	1.000	50.0	42.0	46.0	25.4	50
BES 2086	black	2.086	1.770	1.928	1.000	53.0	45.0	49.0	25.4	25
BES 2205	black	2.205	1.890	2.048	1.000	56.0	48.0	52.0	25.4	25
BES 2480	black	2.480	1.968	2.224	1.000	63.0	50.0	56.5	25.4	25
BES 2520	black	2.520	2.125	2.323	1.000	64.0	54.0	59.0	25.4	25
BES 2677	black	2.677	2.283	2.480	1.000	68.0	58.0	63.0	25.4	25
BES 2953	black	2.953	2.440	2.697	1.377	75.0	62.0	68.5	35.0	25
BES 3543	black	3.543	2.953	3.248	1.535	90.0	75.0	82.5	39.0	10
BES 4055	black	4.055	3.267	3.661	1.535	103.0	83.0	93.0	39.0	10

Current pricing and additional sizes available at [www.epsi.com](http://www.epsi.com)

Not all sizes are available in all warehouse locations - please check with your local sales rep for lead time and availability

# FLP



## Flangless Plugs

- » Designed to be inserted with direct pressure. Not recommended to thread into place. Threading may cause damage to the plug and difficulty during removal
- » Handle for easy removal
- » Tapered ribs and hollow core allow for masking of multiple sizes of holes
- » Sharp rib profile offers excellent chamfer coverage
- » Rigid design allow plug to be pushed into place

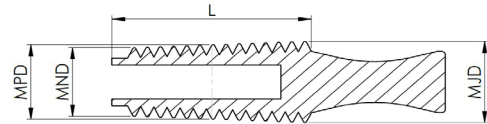

# FLPE

## EPDM Flangless Plugs

Heat resistant up to 475°F (250°C)

Material: EPDM

Duro: 65 +/- 5 Shore

Part number	Color	MJD (in)	MND (in)	MPD (in)	L (in)	MJD (mm)	MND (mm)	MPD (mm)	L (mm)	pcs/bag
FLPE 00402-B	black	0.157	0.079	0.118	0.748	4.0	2.0	3.0	19.0	500
FLPE 00604-B	black	0.236	0.157	0.197	1.000	6.0	4.0	5.0	25.4	250
FLPE 00806-B	black	0.315	0.236	0.276	1.000	8.0	6.0	7.0	25.4	250
FLPE 01008-B	black	0.394	0.315	0.355	1.000	10.0	8.0	9.0	25.4	250
FLPE 01210-B	black	0.472	0.394	0.433	1.000	12.0	10.0	11.0	25.4	250
FLPE 01412-B	black	0.551	0.472	0.512	1.000	14.0	12.0	13.0	25.4	250
FLPE 01614-B	black	0.630	0.551	0.591	1.000	16.0	14.0	15.0	25.4	250
FLPE 01816-B	black	0.709	0.630	0.670	1.000	18.0	16.0	17.0	25.4	250
FLPE 02018-B	black	0.787	0.709	0.748	1.000	20.0	18.0	19.0	25.4	100
FLPE 02220-B	black	0.886	0.787	0.837	1.000	22.5	20.0	21.2	25.4	100
FLPE 02422-B	black	0.945	0.886	0.916	1.000	24.0	22.5	23.3	25.4	100
FLPE 02624-B	black	1.024	0.945	0.985	1.000	26.0	24.0	25.0	25.4	100
FLPE 02826-B	black	1.102	1.024	1.063	1.000	28.0	26.0	27.0	25.4	100
FLPE 03229-B	black	1.250	1.125	1.188	1.000	31.8	28.6	30.2	25.4	100

# FLPS

## Silicone Flangless Plugs

Heat resistant up to 600°F (315°C)

Material: Silicone

Duro: 65 +/- 5 Shore

Part number	Color	MJD (in)	MND (in)	MPD (in)	L (in)	MJD (mm)	MND (mm)	MPD (mm)	L (mm)	pcs/bag
FLPS 00402-N	pink	0.157	0.079	0.118	0.748	4.0	2.0	3.0	19.0	500
FLPS 00604-C	clear	0.236	0.157	0.197	1.000	6.0	4.0	5.0	25.4	250
FLPS 00806-Y	grey	0.315	0.236	0.276	1.000	8.0	6.0	7.0	25.4	250
FLPS 01008-F	rusty	0.394	0.315	0.355	1.000	10.0	8.0	9.0	25.4	250
FLPS 01210-U	blue	0.472	0.394	0.433	1.000	12.0	10.0	11.0	25.4	250
FLPS 01412-C	clear	0.551	0.472	0.512	1.000	14.0	12.0	13.0	25.4	250
FLPS 01614-Y	grey	0.630	0.551	0.591	1.000	16.0	14.0	15.0	25.4	250
FLPS 01816-F	rusty	0.709	0.630	0.670	1.000	18.0	16.0	17.0	25.4	250
FLPS 02018-U	blue	0.787	0.709	0.748	1.000	20.0	18.0	19.0	25.4	100
FLPS 02220-C	clear	0.886	0.787	0.837	1.000	22.5	20.0	21.2	25.4	100
FLPS 02422-Y	grey	0.945	0.886	0.916	1.000	24.0	22.5	23.3	25.4	100
FLPS 02624-F	rusty	rusty	0.945	0.985	1.000	26.0	24.0	25.0	25.4	100
FLPS 02826-U	blue	1.102	1.024	1.063	1.000	28.0	26.0	27.0	25.4	100

Current pricing and additional sizes available at [www.epsi.com](http://www.epsi.com)

Not all sizes are available in all warehouse locations - please check with your local sales rep for lead time and availability



# TPP

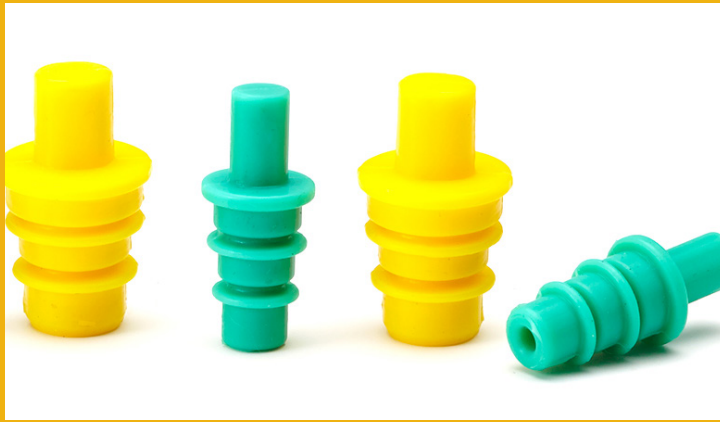

## Triple Push Plugs

Heat resistant up to 600°F (315°C)

Material: Silicone

Duro: 55 +/- 5 Shore

- » Three plugs in one!
- » When inserting TPPs, simply push and twist in threaded hole

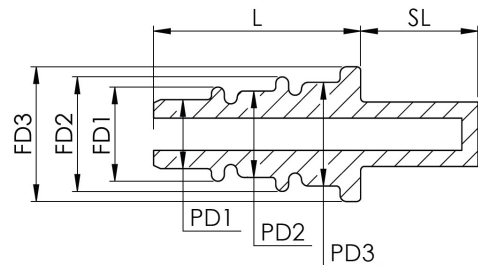

Part number	Color	FD1 (in)	FD2 (in)	FD3 (in)	PD1 (in)	PD2 (in)	PD3 (in)	L (in)	SL (in)	FD1 (mm)	FD2 (mm)	FD3 (mm)	L (mm)	PD1 (mm)	PD2 (mm)	PD3 (mm)	SL (mm)	pcs/ bag
TPP 0375X0500	green	0.425	0.488	0.550	0.318	0.374	0.438	0.805	0.456	10.80	12.40	13.97	20.45	8.08	11.13	11.13	11.58	100
TPP 0563X0750	yellow	0.613	0.675	0.800	0.490	0.537	0.662	0.835	0.456	15.57	17.15	20.32	21.21	12.45	13.64	16.82	11.58	100

Current pricing and additional sizes available at [www.epsi.com](http://www.epsi.com)

Not all sizes are available in all warehouse locations - please check with your local sales rep for lead time and availability





## Liqui-Tite Plugs

Heat resistant up to 600°F (315°C)

Material: Silicone

Duro: 55 +/- 5 Shore

- » Innovative: The best way to seal threaded holes
- » Self Sealing: Spiral threads lock out liquids
- » Fast and Easy: Just push and twist
- » Versatile: Coarse and fine threads on one piece
- » Durable: High-durometer silicone takes repeated uses at high temps

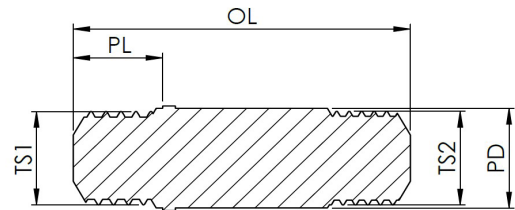

Part number	Color	TS1	TS2	PL (in)	OL (in)	PD (in)	PL (mm)	OL (mm)	PD (mm)	pcs/bag
LTP-138-SC	clear	#6-32	#6-32	0.327	1.375	0.153	8.3	34.9	3.9	500
LTP-164-SP	purple	#8-32	#8-36	0.327	1.375	0.179	8.3	34.9	4.5	500
LTP-190-SN	pink	#10-24	#10-32	0.327	1.375	0.205	8.3	34.9	5.2	500
LTP-250-SO	orange	1/4-20	1/4-28	0.327	1.375	0.265	8.3	34.9	6.7	500
LTP-313-SG	green	5/16-18	5/16-24	0.327	1.375	0.328	8.3	34.9	8.3	500
LTP-375-SY	grey	3/8-16	3/8-24	0.327	1.375	0.390	8.3	34.9	9.9	250
LTP-500-SI	ivory	1/2-13	1/2-20	0.327	1.375	0.515	8.3	34.9	13.1	250
LTP-M06-SU	blue	M6x1	M6X0.75	0.327	1.375	0.251	8.3	34.9	6.4	500
LTP-M08-SL	yellow	M8X1.25	M8X0.75	0.327	1.375	0.330	8.3	34.9	8.4	500
LTP-M10-SF	rusty	M10X1.5	M10X1.25	0.327	1.375	0.409	8.3	34.9	10.4	250
LTP-M12-SR	red	M12X1.5	M12X1.25	0.327	1.375	0.487	8.3	34.9	12.4	250

Current pricing and additional sizes available at [www.epsi.com](http://www.epsi.com)

Not all sizes are available in all warehouse locations - please check with your local sales rep for lead time and availability

# BTM



## Blind-Hole Thread Mask Plugs

Heat resistant up to 600°F (315°C)

Material: Silicone

Duro: 55 +/- 5 Shore

- » Shallow design is ideal for blind hole applications and female threads
- » Flange geometry is specially engineered to mask off lead-in chamfers of threads
- » When sizing, make sure diameter of mask is at least 5% greater than hole size
- » Removes cleanly after use with no shrinkage

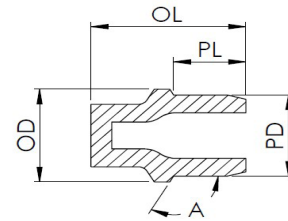

Part number	Color	OL (in)	PD (in)	PL (in)	OD (in)	A	OL (mm)	PD (mm)	PL (mm)	OD (mm)	pcs/bag
BTM 0208-C	clear	0.551	0.208	0.215	0.248	120°	14.0	5.3	5.5	6.3	500
BTM 0218-L	yellow	0.449	0.218	0.201	0.260	120°	11.4	5.5	5.1	6.6	500
BTM 0278-G	green	0.500	0.278	0.201	0.319	120°	12.7	7.1	5.1	8.1	500
BTM 0283-U	blue	0.480	0.283	0.197	0.331	120°	12.2	7.2	5.0	8.4	500
BTM 0336-W	white	0.598	0.336	0.252	0.386	120°	15.2	8.5	6.4	9.8	500
BTM 0358-N	pink	0.591	0.358	0.276	0.409	120°	15.0	9.1	7.0	10.4	250
BTM 0392-O	orange	0.752	0.392	0.350	0.441	100°	19.1	10.0	8.9	11.2	250
BTM 0426-F	rusty	0.791	0.426	0.346	0.492	120°	20.1	10.8	8.8	12.5	250
BTM 0451-C	clear	0.752	0.451	0.350	0.512	120°	19.1	11.5	8.9	13.0	250
BTM 0583-G	green	0.906	0.583	0.433	0.654	120°	23.0	14.8	11.0	16.6	100
BTM 0724-L	yellow	1.122	0.724	0.512	0.811	120°	28.5	18.4	13.0	20.6	100

Current pricing and additional sizes available at [www.epsi.com](http://www.epsi.com)

Not all sizes are available in all warehouse locations - please check with your local sales rep for lead time and availability



# C-BTM



## Blind Thread Collar Plugs

Heat resistant up to 600°F (315°C)

Material: Silicone

Duro: 55 +/- 5 Shore

- » Shallow design is ideal for blind hole applications and female threads
- » Flange geometry is specially engineered to mask off lead-in chamfers of threads
- » Make sure diameter of mask is at least 5% greater than hole size
- » Removes cleanly after use with no shrinkage
- » The additional collar minimizes the paint edge

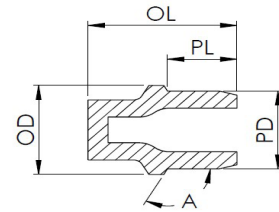

Part number	Color	OD (in)	OL (in)	PD (in)	PL (in)	A	OD (mm)	OL (mm)	PD (mm)	PL (mm)	pcs/bag
C-BTM M06	blue	0.265	0.693	0.218	0.200	120°	6.7	17.6	5.5	5.1	500
C-BTM M08	red	0.360	0.860	0.292	0.270	120°	9.1	21.8	7.4	6.9	500
C-BTM M10	green	0.480	0.860	0.358	0.235	120°	12.2	21.8	9.1	6.0	250
C-BTM M12	yellow	0.540	0.860	0.435	0.240	120°	13.7	21.8	11.0	6.1	250
C-BTM M16	orange	0.700	1.091	0.590	0.370	120°	17.8	27.7	15.0	9.4	100

Current pricing and additional sizes available at [www.epsi.com](http://www.epsi.com)

Not all sizes are available in all warehouse locations - please check with your local sales rep for lead time and availability

# GWPP



## Weld Nut Pull Plugs

Heat resistant up to 600°F (315°C)

Material: Gum-Silicone

Duro: 40 +/- 5 Shore

- » Durable: High tensile silicone takes repeated uses at high temperatures
- » Innovative: Designed for easy pull through removal
- » Self-Sealing: Conforms to irregular surfaces on countersinks and lead-in threads

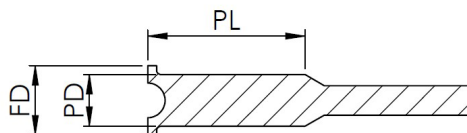

Part number	Color	FD (in)	PD (in)	PL (in)	FD (mm)	PD (mm)	PL (mm)	pcs/bag
GWPP 0173-R	red	0.252	0.173	1.000	6.40	4.39	25.4	500
GWPP 0217-U	blue	0.335	0.217	1.000	8.51	5.51	25.4	500
GWPP 0224-Y	grey	0.343	0.224	1.000	8.71	5.69	25.4	500
GWPP 0283-L	yellow	0.402	0.283	1.000	10.21	7.19	25.4	500
GWPP 0331-O	orange	0.449	0.331	1.000	11.40	8.41	25.4	500
GWPP 0346-N	pink	0.484	0.346	1.000	12.29	8.79	25.4	500
GWPP 0413-G	green	0.506	0.413	1.000	12.85	10.49	25.4	250
GWPP 0439-P	purple	0.557	0.439	1.000	14.15	11.15	25.4	250
GWPP 0490-W	white	0.608	0.490	1.000	15.44	12.45	25.4	250
GWPP 0518-Y	grey	0.636	0.518	1.000	16.15	13.16	25.4	250
GWPP 0545-F	rusty	0.663	0.545	1.000	16.84	13.84	25.4	250
GWPP 0580-R	red	0.699	0.580	1.000	17.75	14.73	25.4	250

Current pricing and additional sizes available at [www.epsi.com](http://www.epsi.com)

Not all sizes are available in all warehouse locations - please check with your local sales rep for lead time and availability

# SPP

## Silicone Pull Plugs



Heat resistant up to 600°F (315°C)

Material: Silicone

Duro: 50 +/- 5 Shore

- » When plugging a hole, make sure the major diameter of the plug is larger than the diameter of the hole being plugged by at least 4%
- » Not recommended for holes with a lead-in chamfer or a countersink that require protection from paint. For these applications, EPSI recommends the Flex-Tite Pull Plug (CPP), the High Tensile Strength Weld Nut Pull Plug (GWPP) or the Washer Plug (WP) lines

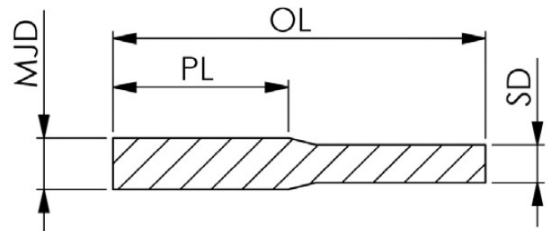

Part number	Color	MJD (in)	OL (in)	PL (in)	SD (in)	MJD (mm)	OL (mm)	PL (mm)	SD (mm)	pcs/bag
SPP 0073X0625-G	green	0.073	1.273	0.625	0.047	1.9	32.3	15.9	1.2	500
SPP 0091X0625-L	yellow	0.091	1.275	0.625	0.062	2.3	32.4	15.9	1.6	500
SPP 0091X1000-L	yellow	0.091	2.034	1.000	0.052	2.3	51.7	25.4	1.3	500
SPP 0093X0625	clear	0.093	1.277	0.625	0.062	2.4	32.4	15.9	1.6	500
SPP 0105X1000-U	blue	0.105	2.030	1.000	0.070	2.7	51.6	25.4	1.8	500
SPP 0109X0625-R	red	0.109	1.291	0.625	0.062	2.8	32.8	15.9	1.6	500
SPP 0109X1000-R	red	0.109	2.041	1.000	0.062	2.8	51.8	25.4	1.6	500
SPP 0118X1000	clear	0.118	2.031	1.000	0.082	3.0	51.6	25.4	2.1	500

Current pricing and additional sizes available at [www.epsi.com](http://www.epsi.com)

Not all sizes are available in all warehouse locations - please check with your local sales rep for lead time and availability

# SPP

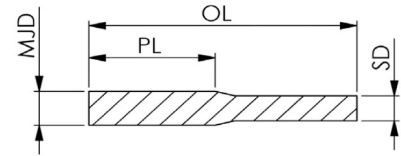

Part number	Color	MJD (in)	OL (in)	PL (in)	SD (in)	MJD (mm)	OL (mm)	PL (mm)	SD (mm)	pcs/bag
SPP 0125X0625-W	white	0.125	1.287	0.625	0.082	3.2	32.7	15.9	2.1	500
SPP 0130X0625-N	pink	0.130	1.292	0.625	0.082	3.3	32.8	15.9	2.1	500
SPP 0130X1000	clear	0.130	2.042	1.000	0.082	3.3	51.9	25.4	2.1	500
SPP 0140X0625-G	green	0.140	1.300	0.625	0.082	3.6	33.0	15.9	2.1	500
SPP 0145X1250-B	black	0.145	2.545	1.250	0.093	3.7	64.6	31.8	2.4	500
SPP 0154X0625-L	yellow	0.154	1.312	0.625	0.082	3.9	33.3	15.9	2.1	500
SPP 0156X0625-Y	grey	0.156	1.314	0.625	0.082	4.0	33.4	15.9	2.1	500
SPP 0156X1250-Y	grey	0.156	2.555	1.250	0.093	4.0	64.9	31.8	2.4	500
SPP 0158X1000-O	orange	0.158	2.056	1.000	0.093	4.0	52.2	25.4	2.4	500
SPP 0158X1500-O	orange	0.158	3.056	1.500	0.093	4.0	77.6	38.1	2.4	500
SPP 0160X0780	clear	0.160	1.596	0.780	0.118	4.1	40.5	19.8	3.0	500
SPP 0162X0625-U	blue	0.162	1.310	0.625	0.093	4.1	33.3	15.9	2.4	500
SPP 0175X1250-P	purple	0.175	2.545	1.250	0.123	4.4	64.6	31.8	3.1	500
SPP 0187X0625-R	red	0.187	1.317	0.625	0.110	4.7	33.5	15.9	2.8	500
SPP 0190X1250-L	yellow	0.190	2.574	1.250	0.140	4.8	65.4	31.8	3.6	500
SPP 0195X0625-W	white	0.195	1.324	0.625	0.110	5.0	33.6	15.9	2.8	500
SPP 0195X1250-W	white	0.195	2.574	1.250	0.110	5.0	65.4	31.8	2.8	500
SPP 0197X1000-F	rusty	0.197	2.075	1.000	0.110	5.0	52.7	25.4	2.8	500
SPP 0218X1000	clear	0.218	2.094	1.000	0.110	5.5	53.2	25.4	2.8	500
SPP 0225X1000-N	pink	0.225	2.087	1.000	0.125	5.7	53.0	25.4	3.2	500
SPP 0225X1181-N	pink	0.225	2.453	1.181	0.120	5.7	62.3	30.0	3.0	500
SPP 0236X0400-O	orange	0.236	0.851	0.400	0.177	6.0	21.6	10.2	4.5	500
SPP 0236X1250-O	orange	0.236	2.561	1.250	0.165	6.0	65.0	31.8	4.2	500
SPP 0244X1250-P	purple	0.244	2.564	1.250	0.170	6.2	65.1	31.8	4.3	500
SPP 0257-G	green	0.257	2.110	1.000	0.130	6.5	53.6	25.4	3.3	500
SPP 0260-U	blue	0.260	2.113	1.000	0.130	6.6	53.7	25.4	3.3	500
SPP 0265-Y	grey	0.265	2.568	1.250	0.186	6.7	65.2	31.8	4.7	500
SPP 0275-L	yellow	0.275	2.026	0.950	0.130	7.0	51.5	24.1	3.3	500
SPP 0281-R	red	0.281	2.124	1.000	0.138	7.1	53.9	25.4	3.5	500
SPP 0312X1000-Y	grey	0.312	2.143	1.000	0.147	7.9	54.4	25.4	3.7	500
SPP 0312X1250-Y	grey	0.312	2.608	1.250	0.187	7.9	66.2	31.8	4.7	500
SPP 0332-U	blue	0.332	2.321	0.750	0.250	8.4	52.6	31.8	6.4	500
SPP 0335-W	white	0.335	2.154	1.000	0.157	8.5	54.7	25.4	4.0	500
SPP 0350	clear	0.350	1.967	0.900	0.157	8.9	50.0	22.9	4.0	500
SPP 0375-L	yellow	0.375	2.189	1.000	0.157	9.5	55.6	25.4	4.0	250
SPP 0388-R	red	0.388	2.200	1.000	0.157	9.9	55.9	25.4	4.0	250
SPP 0400X1000	clear	0.400	2.334	1.000	0.157	10.2	59.3	25.4	4.0	250

Current pricing and additional sizes available at [www.epsi.com](http://www.epsi.com)

Not all sizes are available in all warehouse locations - please check with your local sales rep for lead time and availability



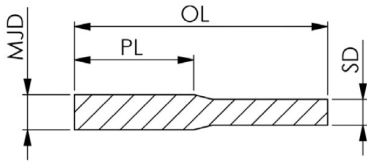

# SPP

Part number	Color	MJD (in)	OL (in)	PL (in)	SD (in)	MJD (mm)	OL (mm)	PL (mm)	SD (mm)	pcs/bag
SPP 0414-G	green	0.414	2.223	1.000	0.157	10.5	56.5	25.4	4.0	250
SPP 0437-F	rusty	0.437	2.113	1.250	0.306	11.1	53.7	31.8	7.8	250
SPP 0440-L	yellow	0.440	2.245	1.000	0.157	11.2	57.0	25.4	4.0	250
SPP 0440X2000-B	black	0.440	4.245	2.000	0.306	11.2	107.8	50.8	7.8	250
SPP 0445-Y	grey	0.445	2.165	1.000	0.255	11.3	55.0	25.4	6.5	250
SPP 0468-U	blue	0.468	2.689	1.250	0.250	11.9	68.3	31.8	6.4	250
SPP 0500-W	white	0.500	2.217	1.000	0.250	12.7	56.3	25.4	6.4	100
SPP 0510	clear	0.510	2.225	1.000	0.250	13.0	56.5	25.4	6.4	100
SPP 0530-N	pink	0.530	2.242	1.000	0.250	13.5	56.9	25.4	6.4	100
SPP 0551	clear	0.551	2.623	1.181	0.250	14.0	66.6	30.0	6.4	100
SPP 0580-F	rusty	0.580	3.229	1.500	0.315	14.7	82.0	38.1	8.0	100
SPP 0590-R	red	0.590	2.294	1.000	0.250	15.0	58.3	25.4	6.4	100
SPP 0612-L	yellow	0.612	2.314	1.000	0.250	15.5	58.8	25.4	6.4	100
SPP 0640X1000-Y	grey	0.640	2.229	1.000	0.375	16.3	56.6	25.4	9.5	100
SPP 0640X1772	clear	0.640	3.773	1.772	0.375	16.3	95.8	45.0	9.5	100
SPP 0700X1250-U	blue	0.700	2.781	1.250	0.375	17.8	70.6	31.8	9.5	100
SPP 0700X1500-U	blue	0.700	3.285	1.500	0.371	17.8	83.4	38.1	9.4	100
SPP 0729X1000-W	white	0.729	2.359	1.000	0.315	18.5	59.9	25.4	8.0	100
SPP 0729X1500-W	white	0.729	3.297	1.500	0.386	18.5	83.7	38.1	9.8	100
SPP 0740	clear	0.740	4.074	1.890	0.364	18.8	103.5	48.0	9.2	100
SPP 0770X1125	clear	0.770	2.592	1.125	0.375	19.6	65.8	28.6	9.5	50
SPP 0770X1500	clear	0.770	3.314	1.500	0.408	19.6	84.2	38.1	10.4	50
SPP 0809X1000-N	pink	0.809	2.428	1.000	0.315	20.5	61.7	25.4	8.0	50
SPP 0896X1000-G	green	0.896	2.451	1.000	0.375	22.8	62.3	25.4	9.5	50
SPP 1020-L	yellow	1.020	3.059	1.250	0.375	25.9	77.7	31.8	9.5	50
SPP 1265-U	blue	1.265	5.514	2.470	0.625	32.1	140.1	62.7	15.9	50
SPP 2000-F	rusty	2.000	5.050	2.000	0.787	50.8	128.3	50.8	20.0	25

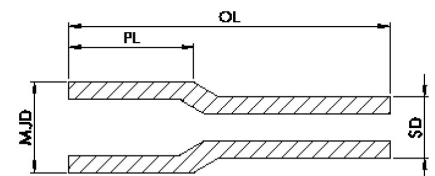

## HOLLOW SPP SERIES

Part number	Color	MJD (in)	OL (in)	PL (in)	SD (in)	MJD (mm)	OL (mm)	PL (mm)	SD (mm)	pcs/bag
SPP 0370	clear	0.370	2.520	0.454	0.187	9.4	64.0	11.5	4.7	250
SPP 1024-L	yellow	1.024	4.000	1.772	0.689	26.0	101.6	45.0	17.5	50
SPP 1713-L	yellow	1.713	6.250	2.756	0.866	43.5	158.8	70.0	22.0	50
SPP 2280-L	yellow	2.280	6.000	2.000	1.140	57.9	152.4	50.8	29.0	10

# EPP



## EPDM Pull Plugs

Heat resistant up to 475°F (245°C)

Material: EPDM

Duro: 50 +/- 5 Shore

- » When plugging a hole, make sure that the major diameter of the plug is larger than the diameter of the hole being plugged by at least 4%
- » Not recommended for holes with a lead-in chamfer or a countersink that requires protection from paint. For these applications, EPSI recommends the Flex-Tite Pull Plug (CPP), the High Tensile Strength Weld Nut Pull Plug (GWPP) or the Washer Plug (WP) lines
- » Chamfered neck and smaller pull-tab diameter aid insertion
- » When pulled through holes, large diameter compresses providing a tight seal
- » High temperature EPDM formulation is extremely chemical resistant and economical

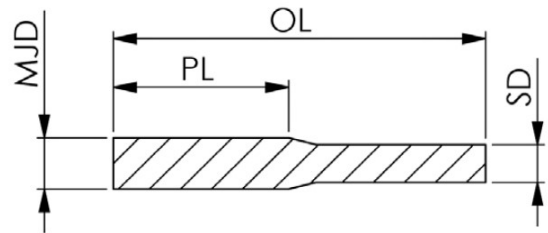



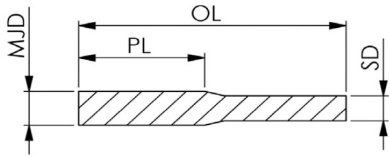

# EPP

Part number	Color	MJD (in)	OL (in)	PL (in)	SD (in)	MJD (mm)	OL (mm)	PL (mm)	SD (mm)	pcs/bag
EPP 0093	black	0.093	1.277	0.625	0.062	2.4	32.4	15.9	1.6	500
EPP 0109X0625	black	0.109	1.291	0.625	0.062	2.8	32.8	15.9	1.6	500
EPP 0118	black	0.118	2.031	1.000	0.082	3.0	51.6	25.4	2.1	500
EPP 0130X0625	black	0.130	1.292	0.625	0.082	3.3	32.8	15.9	2.1	500
EPP 0140	black	0.140	1.300	0.625	0.082	3.6	33.0	15.9	2.1	500
EPP 0154	black	0.154	1.312	0.625	0.082	3.9	33.3	15.9	2.1	500
EPP 0156X0625	black	0.156	1.314	0.625	0.082	4.0	33.4	15.9	2.1	500
EPP 0162	black	0.162	1.310	0.625	0.093	4.1	33.3	15.9	2.4	500
EPP 0187	black	0.187	1.317	0.625	0.110	4.7	33.5	15.9	2.8	500
EPP 0195X0625	black	0.195	1.324	0.625	0.110	5.0	33.6	15.9	2.8	500
EPP 0197X1000	black	0.197	2.075	1.000	0.110	5.0	52.7	25.4	2.8	500
EPP 0225	black	0.225	2.087	1.000	0.125	5.7	53.0	25.4	3.2	500
EPP 0281	black	0.281	2.124	1.000	0.138	7.1	53.9	25.4	3.5	500
EPP 0312X1000	black	0.312	2.143	1.000	0.147	7.9	54.4	25.4	3.7	500
EPP 0332	black	0.332	2.071	1.125	0.250	8.4	52.6	28.6	6.4	500
EPP 0335	black	0.335	2.154	1.000	0.157	8.5	54.7	25.4	4.0	500
EPP 0350	black	0.350	1.967	0.900	0.157	8.9	50.0	22.9	4.0	500
EPP 0388	black	0.388	2.200	1.000	0.157	9.9	55.9	25.4	4.0	250
EPP 0400X1000	black	0.400	2.334	1.000	0.157	10.2	59.3	25.4	4.0	250
EPP 0445	black	0.445	2.165	1.000	0.255	11.3	55.0	25.4	6.5	250
EPP 0468	black	0.468	2.689	1.250	0.250	11.9	68.3	31.8	6.4	250
EPP 0500	black	0.500	2.217	1.000	0.250	12.7	56.3	25.4	6.4	100
EPP 0770X1125	black	0.770	2.592	1.125	0.375	19.6	65.8	28.6	9.5	50
EPP 1020	black	1.020	3.059	1.250	0.375	25.6	77.7	31.8	9.5	50

Current pricing and additional sizes available at [www.epsi.com](http://www.epsi.com)

Not all sizes are available in all warehouse locations - please check with your local sales rep for lead time and availability



# MSPP



## Multi Step Pull Plugs

Heat resistant up to 600°F (315°C)

Material: Silicone

Duro: 50 +/- 5 Shore

- » Convenient: A single MSPP replaces three of the most popular pull plug sizes. The reduces inventory and requires less logistics because of its versatility
- » Durable: Made of durable, high temperature resistant silicone for repeated use
- » Versatile: Next larger diameter on the same plug can be used to achieve a tighter fit

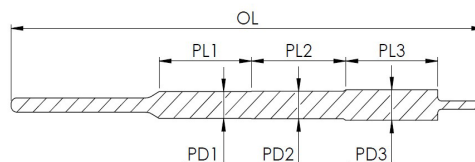

Part number	Color	PD1 (in)	PD2 (in)	PD3 (in)	PL1 (in)	PL2 (in)	PL3 (in)	OL (in)	PD1 (mm)	PD2 (mm)	PD3 (mm)	PL1 (mm)	PL2 (mm)	PL3 (mm)	OL (mm)	pcs/bag
MSPP 0109X1000-SXN	pink	0.073	0.105	0.109	1.000	1.000	1.000	4.781	1.85	2.67	2.77	25.4	25.4	25.4	25.4	750
MSPP 0140X1000-SXL	yellow	0.118	0.130	0.140	1.000	1.000	1.000	4.849	3.00	3.30	3.56	25.4	25.4	25.4	25.4	300
MSPP 0195X1000-SXG	green	0.156	0.175	0.195	1.000	1.000	1.000	4.939	3.96	4.45	4.95	25.4	25.4	25.4	25.4	200
MSPP 0257X1000-SXU	blue	0.218	0.225	0.257	1.000	1.000	1.000	5.027	5.54	5.72	6.53	25.4	25.4	25.4	25.4	100
MSPP 0312X1000-SXP	purple	0.275	0.281	0.312	1.000	1.000	1.000	6.164	6.99	7.14	7.92	25.4	25.4	25.4	25.4	100

Current pricing and additional sizes available at [www.epsi.com](http://www.epsi.com)

Not all sizes are available in all warehouse locations - please check with your local sales rep for lead time and availability



# EMT/SMT



## Mousetail Plugs

Heat resistant up to 600°F (315°C)

Material: Silicone

Duro: 55 +/- 5 Shore

- » Can be stretched to provide a leak-proof seal
- » Ideal for plugging small or hard to reach holes
- » EMT provides greater resistance to chemicals and hydrocarbons

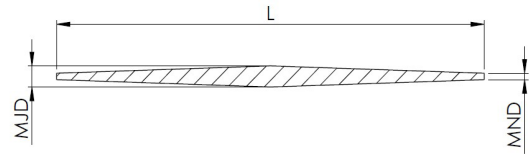

## EPDM Mousetail Plugs

Heat resistant up to 475°F (250°C)

Material: EPDM

Duro: 65 +/- 5 Shore

Part number	Color	MJD (in)	MND (in)	L (in)	MJD (mm)	MND (mm)	L (mm)	pcs/bag
EMT 0079	black	0.079	0.022	1.332	2.0	0.6	33.8	1000
EMT 0080	black	0.080	0.023	2.083	2.0	0.6	52.9	1000
EMT 0083	black	0.083	0.031	1.928	2.1	0.8	49.0	1000
EMT 0100	black	0.100	0.030	2.080	2.5	0.8	52.8	1000

## Silicone Mousetail Plugs

Heat resistant up to 600°F (15°C)

Material: Silicone

Duro: 65 +/- 5 Shore

Part number	Color	MJD (in)	MND (in)	L (in)	MJD (mm)	MND (mm)	L (mm)	pcs/bag
SMT 0079	clear	0.079	0.022	1.332	2.0	0.6	33.8	1000
SMT 0080	clear	0.080	0.023	2.083	2.0	0.6	52.9	1000
SMT 0083	clear	0.083	0.031	1.928	2.1	0.8	49.0	1000
SMT 0100	clear	0.100	0.030	2.080	2.5	0.8	52.8	1000

# CPP



## Flex-Tite Dual Countersink Pull Plugs

Heat resistant up to 600°F (315°C)

Material: Silicone

Duro: 55 +/- 5 Shore

- » Innovative: The best way to mask 82° / 90° / 100° countersink holes
- » Self-Sealing: Crucial point first contact design ensures a liquid tight seal
- » Fast and Easy: Pull tabs ensure easy application and removal
- » Durable: High-grade silicone takes repeated use at high temperatures

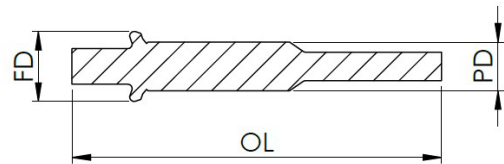

Part number	Color	PD (in)	FD (in)	OL (in)	PD (mm)	FD (mm)	OL (mm)	pcs/bag
CPP 0220X0368-R	red	0.220	0.368	2.570	5.59	9.35	65.28	250
CPP 0243X0402-Y	grey	0.243	0.402	2.570	6.17	10.21	65.28	250
CPP 0280X0493-L	yellow	0.280	0.439	2.680	7.11	11.15	68.07	250
CPP 0280X0515-B	black	0.280	0.515	2.580	7.11	13.08	65.53	250
CPP 0293X0422-N	pink	0.293	0.422	2.560	7.44	10.72	65.02	250
CPP 0302X0532-U	blue	0.302	0.532	2.580	7.67	13.51	65.53	250
CPP 0343X0464-W	white	0.343	0.464	2.580	8.71	11.79	65.53	250
CPP 0343X0487-C	clear	0.343	0.487	2.590	8.71	12.37	65.79	250
CPP 0343X0620-G	green	0.343	0.620	2.620	8.71	15.75	66.55	250
CPP 0343X0642-P	purple	0.343	0.642	2.620	8.71	16.31	66.55	250
CPP 0365X0660-R	red	0.365	0.660	2.630	9.27	16.76	66.80	250
CPP 0405X0744-Y	grey	0.405	0.744	2.670	10.29	18.90	67.82	250
CPP 0428X0787-L	yellow	0.428	0.787	2.680	10.87	19.99	68.07	250

Current pricing and additional sizes available at [www.epsi.com](http://www.epsi.com)

Not all sizes are available in all warehouse locations - please check with your local sales rep for lead time and availability

# DWP



## Double Washer Pull Plugs

Heat resistant up to 600°F (315°C)

Material: Silicone

Duro: 50 +/- 5 Shore

- » When plugging a hole, make sure that the plug diameter is larger than the diameter of the hole being plugged by at least 5%
- » To insert plug, place long stem into hole. Pull through until flanges are securely positioned around your part. To remove plug, pull short stem in reverse direction
- » Masks entry and exit threads simultaneously
- » Designed for common metric threads
- » Provides positive seal
- » Don't see the size you need? Ask about custom sizing!

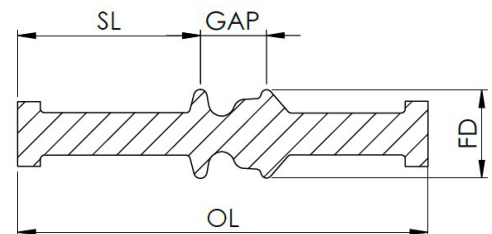

Part number	Color	FD (in)	OL (in)	GAP (in)	SL (in)	FD (mm)	OL (mm)	GAP (mm)	SL (mm)	pcs/bag
DWP M04	white	0.174	1.044	0.125	0.465	4.4	26.5	3.2	11.8	1000
DWP M05	green	0.207	1.175	0.140	0.533	5.3	29.8	3.6	13.5	1000
DWP M06	blue	0.243	1.239	0.176	0.574	6.2	31.5	4.5	14.6	1000
DWP M08	yellow	0.323	1.500	0.242	0.668	8.2	38.1	6.1	17.0	1000
DWP M10	brown	0.410	1.643	0.322	0.717	10.4	41.7	8.2	18.2	500
DWP M12	red	0.503	1.870	0.377	0.820	12.8	47.5	9.6	20.8	500
DWP M16	green	0.658	2.282	0.495	1.057	16.7	58.0	12.6	26.8	250
DWP M18	red	0.748	2.282	0.495	1.074	19.0	58.0	12.6	27.3	100
DWP M20	purple	0.866	2.816	0.512	1.617	22.0	71.5	13.0	41.1	100
DWP M22	grey	0.945	2.816	0.512	1.633	24.0	71.5	13.0	41.5	100

Current pricing and additional sizes available at [www.epsi.com](http://www.epsi.com)

Not all sizes are available in all warehouse locations - please check with your local sales rep for lead time and availability

# C-DWP



## Double Washer Pull Plugs with Colored Tip

Heat resistant up to 600°F (315°C)

Material: Silicone

Duro: 55 +/- 5 Shore

- » When plugging a hole, make sure that the plug diameter is larger than the diameter of the hole being plugged by at least 5%
- » To insert plug, place bullet nose into hole. Pull through until flanges are securely positioned around your part. To remove plug, pull short stem in reverse direction
- » Removes cleanly after use with no shrinkage

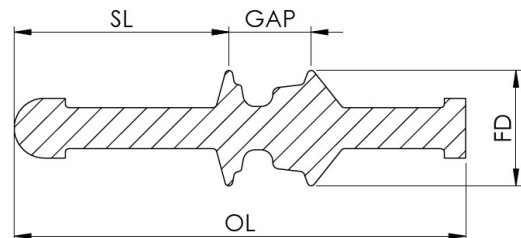

Part number	Color	FD (in)	OL (in)	GAP (in)	SL (in)	FD (mm)	OL (mm)	GAP (mm)	SL (mm)	pcs/bag
C-DWP M06 BLUE w/RED TIP	blue w/ red tip	0.243	1.239	0.175	0.574	6.2	31.5	4.4	14.6	1000
C-DWP M08 RED w/BLUE TIP	red w/ blue tip	0.323	1.500	0.242	0.668	8.2	38.1	6.1	17.0	1000
C-DWP M10 GREEN w/YELLOW TIP	green w/ yellow tip	0.410	1.643	0.322	0.717	10.4	41.7	8.2	18.2	500
C-DWP M12 YELLOW w/BLUE TIP	yellow w/ blue tip	0.503	1.870	0.377	0.820	12.8	47.5	9.6	20.8	500
C-DWP M16 ORANGE w/GREEN TIP	orange w/ green tip	0.658	2.282	0.495	1.057	16.7	58.0	12.6	26.8	250

Current pricing and additional sizes available at [www.epsi.com](http://www.epsi.com)

Not all sizes are available in all warehouse locations - please check with your local sales rep for lead time and availability



# DFP



## Dual Flanged Push Plugs

Heat resistant up to 600°F (315°C)

Material: Silicone

Duro: 55 +/- 5 Shore

- » Fast and Easy: Ergo-designed handle allows for quick installation and removal
- » Convenient: Designed to fit the most common metric and inch weld nut sizes
- » Durable: Made with NE-G high-grade, high-temp silicone to stand up to abuse and repeated use

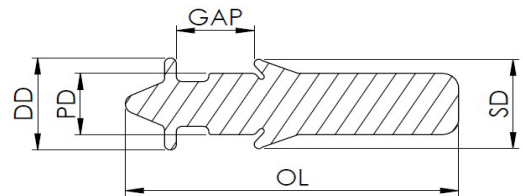

Part number	Color	PD (in)	GAP (in)	DD (in)	SD (in)	OL (in)	PD (mm)	GAP (mm)	DD (mm)	SD (mm)	OL (mm)	pcs/bag
DFP-250M06-SU	blue	0.187	0.254	0.275	0.265	0.882	4.75	6.45	6.99	6.73	22.40	500
DFP-313M08-SL	yellow	0.247	0.281	0.370	0.360	1.203	6.27	7.14	9.40	9.14	30.56	500
DFP-375M10-SF	rusty	0.303	0.327	0.460	0.450	1.370	7.70	8.31	11.68	11.43	34.80	250
DFP-500M12-SR	red	0.392	0.379	0.550	0.540	1.680	9.96	9.63	13.97	13.72	42.67	250
DFP-625M16-SO	orange	0.521	0.481	0.355	0.700	2.103	13.23	12.22	9.02	17.78	53.42	100

Current pricing and additional sizes available at [www.epsi.com](http://www.epsi.com)

Not all sizes are available in all warehouse locations - please check with your local sales rep for lead time and availability

# SOMS



## Sink-O-Mask Plugs™

Heat resistant up to 600°F (315°C)

Material: Silicone

Duro: 55 +/- 5 Shore

- » When plugging a hole, make sure the plug diameter is larger than the diameter of the hole being plugged by at least 5%
- » Sink-O-Mask™ Plugs feature pull tabs for easy removal after coating

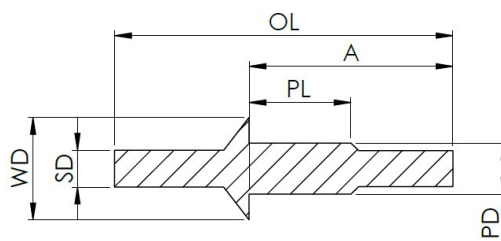

Part number	Color	OL (in)	PD (in)	A (in)	PL (in)	WD (in)	SD (in)	OL (mm)	PD (mm)	A (mm)	PL (mm)	WD (mm)	SD (mm)	pcs/bag
SOMS X2012-C	clear	1.920	0.118	1.448	0.433	0.197	0.138	48.8	3.0	36.8	11.0	5.0	3.5	500
SOMS X3116-C	clear	1.232	0.157	0.787	0.394	0.311	0.118	31.3	4.0	20.0	10.0	7.9	3.0	500
SOMS X4016-C	clear	1.378	0.157	0.821	0.394	0.394	0.138	35.0	4.0	20.9	10.0	10.0	3.5	500
SOMS X4020-C	clear	1.307	0.197	0.787	0.394	0.394	0.138	33.2	5.0	20.0	10.0	10.0	3.5	500
SOMS X4032-C	clear	1.575	0.315	0.984	0.394	0.394	0.138	40.0	8.0	25.0	10.0	10.0	3.5	500
SOMS X4816-C	clear	2.081	0.157	1.541	0.500	0.472	0.394	52.9	4.0	39.1	12.7	12.0	10.0	500
SOMS X5317-C	clear	1.437	0.165	0.846	1.437	0.53	0.165	36.5	4.2	21.5	36.5	13.5	4.2	500
SOMS X6020-C	clear	1.606	0.197	1.016	0.394	0.591	0.197	40.8	5.0	25.8	10.0	15.0	5.0	250
SOMS X6024-C	clear	1.378	0.236	0.787	0.394	0.591	0.197	35.0	6.0	20.0	10.0	15.0	5.0	250
SOMS X6032-C	clear	1.555	0.315	0.994	0.394	0.591	0.197	39.5	8.0	25.2	10.0	15.0	5.0	250
SOMS X6540-C	clear	1.762	0.394	1.169	0.382	0.649	0.295	44.8	10.0	29.7	9.7	16.5	7.5	250
SOMS X7940-C	clear	1.783	0.394	1.177	0.394	0.787	0.295	45.3	10.0	29.9	10.0	20.0	7.5	100
SOMS X7948-C	clear	1.862	0.472	1.272	0.394	0.787	0.295	47.3	12.0	32.3	10.0	20.0	7.5	100

Current pricing and additional sizes available at [www.epsi.com](http://www.epsi.com)

Not all sizes are available in all warehouse locations - please check with your local sales rep for lead time and availability





# SMS



## Silicone Masking Stoppers

Heat resistant up to 600°F (315°C)

Material: Silicone

Duro: 55 +/- 5 Shore

- » Reusable, does not melt or harden
- » Easy combination of different sizes
- » Fits hole diameters from 25.0 mm to 120.0 mm
- » Prevents the plugs from "popping out" in the oven
- » Flexible spacing of plugs on the connecting plugs possible
- » Versatile use - can be used with or without TSS product

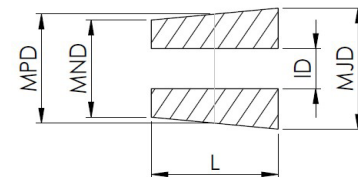

Part number	Color	ID (in)	MJD (in)	MND (in)	MPD (in)	L (in)	ID (mm)	MJD (mm)	MND (mm)	MPD (mm)	L (mm)	pcs/bag
SMS 0650	clear	0.350	0.755	0.545	0.650	1.000	8.9	19.2	13.8	16.5	25.4	50
SMS 0750	clear	0.350	0.855	0.645	0.750	1.000	8.9	21.7	16.4	19.1	25.4	50
SMS 0850	clear	0.350	0.955	0.745	0.850	1.000	8.9	24.3	18.9	21.6	25.4	50
SMS 0950	clear	0.350	1.055	0.845	0.950	1.000	8.9	26.8	21.5	24.1	25.4	50
SMS 1050	clear	0.350	1.155	0.945	1.050	1.000	8.9	29.3	24.0	26.7	25.4	50
SMS 1150	clear	0.350	1.255	1.045	1.150	1.000	8.9	31.9	26.5	29.2	25.4	50
SMS 1250	clear	0.350	1.355	1.140	1.248	1.000	8.9	34.4	29.0	31.7	25.4	50
SMS 1350	clear	0.350	1.455	1.245	1.350	1.000	8.9	37.0	31.6	34.3	25.4	50
SMS 1450	clear	0.350	1.555	1.345	1.450	1.000	8.9	39.5	34.2	36.8	25.4	50
SMS 1550	clear	0.350	1.655	1.445	1.550	1.000	8.9	42.0	36.7	39.4	25.4	50
SMS 1650	clear	0.350	1.755	1.545	1.650	1.000	8.9	44.6	39.2	41.9	25.4	50
SMS 1850	clear	0.350	1.955	1.745	1.850	1.000	8.9	49.7	44.3	47.0	25.4	25
SMS 1950	clear	0.350	2.055	1.845	1.950	1.000	8.9	52.2	46.9	49.5	25.4	25
SMS 2050	clear	0.350	2.155	1.945	2.050	1.000	8.9	54.7	49.4	52.1	25.4	50
SMS 2150	clear	0.350	2.255	2.045	2.150	1.000	8.9	57.3	51.9	54.6	25.4	50
SMS 2250	clear	0.350	2.355	2.145	2.250	1.000	8.9	59.8	54.5	57.2	25.4	25
SMS 2350	clear	0.350	2.455	2.245	2.350	1.000	8.9	62.4	57.0	59.7	25.4	25
SMS 2450	clear	0.350	2.555	2.345	2.450	1.000	8.9	64.9	59.6	62.2	25.4	25
SMS 2550	clear	0.350	2.655	2.445	2.550	1.000	8.9	67.4	62.1	64.8	25.4	50
SMS 2650	clear	0.350	2.755	2.545	2.650	1.000	8.9	70.0	64.6	67.3	25.4	25
SMS 3050	clear	0.350	3.155	2.945	3.050	1.000	8.9	80.1	74.8	77.5	25.4	50
SMS 3550	clear	0.350	3.655	3.445	3.550	1.000	8.9	92.8	87.5	90.2	25.4	50

# TSS



## Silicone Masking Stem for Silicone Masking Stoppers

Heat resistant up to 600°F (315°C)

Material: Silicone

Duro: 55 +/- 5 Shore

» Combination Plug for SMS

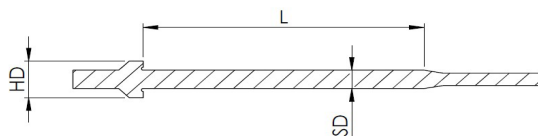

Part number	Color	SD (in)	L (in)	HD (in)	SD (mm)	L (mm)	HD (mm)	pcs/bag
TSS 2000	orange	0.380	2.000	0.750	9.65	50.8	19.05	25
TSS 5000	yellow	0.375	5.000	0.750	9.53	127.0	19.05	25
TSS 12000	green	0.375	12.000	0.750	9.53	304.8	19.05	25
TSS 15000	blue	0.375	15.000	0.750	9.53	381.0	19.05	25

Current pricing and additional sizes available at [www.epsi.com](http://www.epsi.com)

Not all sizes are available in all warehouse locations - please check with your local sales rep for lead time and availability



## Thread-N-Mask Plugs

Heat resistant up to 185°F (85°C)

Material: LDPE Plastic

- » Self-threading, forming leak proof seal
- » It is recommended that at least 1/4 of the plug be threaded into the hole

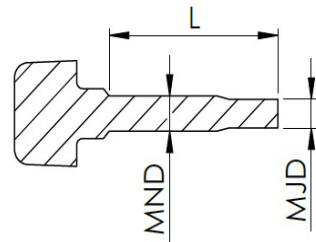

Part number	Color	MJD (in)	MND (in)	L (in)	MJD (mm)	MND (mm)	L (mm)	pcs/bag
TNM 0082	white	0.082	0.062	0.660	2.1	1.6	16.8	500
TNM 0100	white	0.100	0.080	0.600	2.5	2.0	15.2	500
TNM 0106	white	0.106	0.085	0.668	2.7	2.2	17.0	500
TNM 0120	white	0.120	0.095	0.735	3.0	2.4	18.7	500
TNM 0131	white	0.131	0.105	0.803	3.3	2.7	20.4	500
TNM 0156	white	0.156	0.136	0.780	4.0	3.5	19.8	500
TNM 0171	white	0.171	0.143	0.800	4.3	3.6	20.3	500
TNM 0186	white	0.186	0.150	0.820	4.7	3.8	20.8	250
TNM 0212	white	0.212	0.180	0.895	5.4	4.6	22.7	250
TNM 0270	white	0.270	0.210	1.120	6.9	5.3	28.4	250
TNM 0335	white	0.335	0.295	0.890	8.5	7.5	22.6	250
TNM 0400	white	0.400	0.348	1.005	10.2	8.8	25.5	250
TNM 0470	white	0.470	0.400	1.120	11.9	10.2	28.4	250

Current pricing and additional sizes available at [www.epsi.com](http://www.epsi.com)

Not all sizes are available in all warehouse locations - please check with your local sales rep for lead time and availability

# ETNM

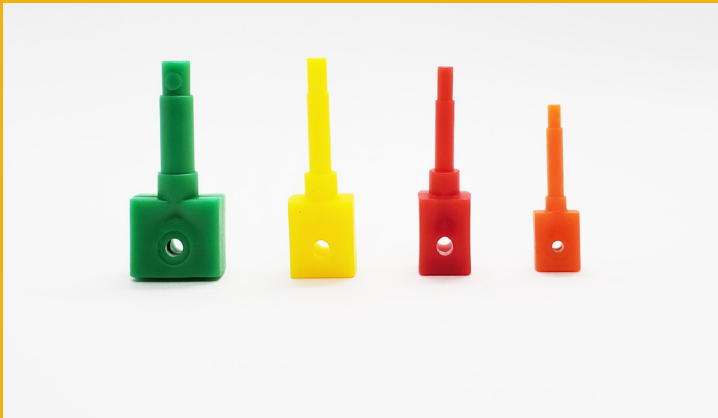

## Ergonomic Thread-N-Mask Plugs

Heat resistant up to 149°F (65°C)

Material: HDPE Plastic

- » Self-threading, forming a leak-proof seal
- » It is recommended that at least 1/4 of the plug be threaded into the hole

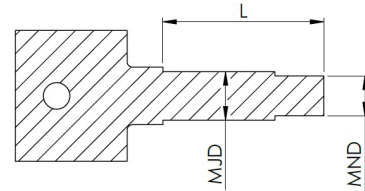

Part number	Color	MJD (in)	MND (in)	L (in)	MJD (mm)	MND (mm)	L (mm)	PCS/BAG	TYPICAL APPLICATION
ETNM 0082	clear	0.078	0.060	0.530	2.0	1.5	13.5	500	#2-56 and #2-64 threads
ETNM 0106	orange	0.103	0.080	0.621	2.6	2.0	15.8	500	#4-40 and #4-48 threads
ETNM 0131	red	0.126	0.100	0.709	3.2	2.5	18.0	500	#6-32 and #6-40 threads
ETNM 0156	yellow	0.150	0.130	0.791	3.8	3.3	20.1	500	#8-32 and #8-36 threads
ETNM 0171	clear	0.175	0.143	0.791	4.4	3.6	20.1	500	#10-24 and #10-32 threads
ETNM 0212	green	0.232	0.191	0.771	5.9	4.9	19.6	250	1/4-20 and 1/4-28 threads

Current pricing and additional sizes available at [www.epsi.com](http://www.epsi.com)

Not all sizes are available in all warehouse locations - please check with your local sales rep for lead time and availability

# TIPS



## Tube Insert Plugs

Heat resistant up to 600°F (315°C)

Material: Silicone

Duro: 55 +/- 5 Shore

- » When plugging a hole, make sure that the major diameter of the plug is at least 10% larger than the diameter of the hole being plugged
- » Flat washer will cover only the tube end
- » U-Channel washer can extend over tube end
- » Well suited for liquid tight seal, and resistance to blow-out

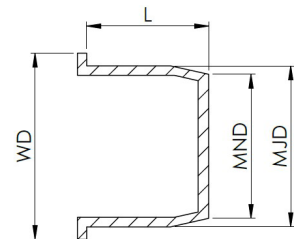
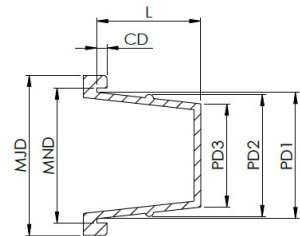

Part number	Color	MJD (in)	MND (in)	PD (in)	PD1 (in)	PD2 (in)	PD3 (in)	CD (in)	WD (in)	L (in)	MJD (mm)	MND (mm)	PD (mm)	PD1 (mm)	PD2 (mm)	PD3 (mm)	CD (mm)	WD (mm)	L (mm)	pcs/bag	open/closed
TIPS 022033-F	rusty	1.272	1.072	0.858	X	X	X	0.130	1.272	1.339	32.3	27.2	21.8	X	X	X	3.3	32.3	34.0	100	closed
TIPS 027034-U	blue	X	X	0.941	X	X	X	X	1.335	0.980	X	X	23.9	X	X	X	X	33.9	24.9	100	closed
TIPS 029037-F	rusty	1.449	1.309	1.157	X	X	X	0.126	X	1.449	36.8	33.2	29.4	X	X	X	3.2	X	36.8	100	closed
TIPS 031041-F	rusty	X	X	1.228	X	X	X	X	1.598	1.063	X	X	31.2	X	X	X	X	40.6	27.0	100	closed
TIPS 033039-F	rusty	1.299	0.961	X	X	X	X	X	1.535	1.201	33.0	24.4	X	X	X	X	X	39.0	30.5	100	closed
TIPS 038048-F	rusty	1.870	1.634	X	1.495	1.46	1.190	0.120	X	1.319	47.5	41.5	X	38.0	37.1	30.2	3.0	X	33.5	100	closed
TIPS 042052-F	rusty	2.035	1.862	1.645	X	X	X	0.199	X	2.035	51.7	47.3	41.8	X	X	X	5.1	X	51.7	100	closed
TIPS 047056-F	rusty	2.201	2.040	1.850	X	X	X	0.170	X	1.500	55.9	51.8	47.0	X	X	X	4.3	X	38.1	50	open

Current pricing and additional sizes available at [www.epsi.com](http://www.epsi.com)

Not all sizes are available in all warehouse locations - please check with your local sales rep for lead time and availability

# TOPS



## Shallow Tube Plugs

Heat resistant up to 600°F (315°C)

Material: Silicone

Duro: 55 +/- 5 Shore

- » When plugging a hole, make sure that the major diameter of the plug is at least 10% larger than the diameter of the hole being plugged
- » Mask both ends of shallow machined bores with two plugs
- » Off-Set Handle for Easy Removal

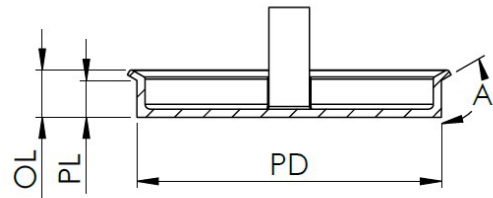

Part number	Color	OL (in)	PD (in)	PL (in)	A	OL (mm)	PD (mm)	PL (mm)	pcs/bag
TOPS 036020-L	yellow	0.320	1.400	0.200	90	8.1	35.6	5.1	100
TOPS 041016-L	yellow	0.618	1.598	0.434	135	15.7	40.6	11.0	100
TOPS 046006-L	yellow	0.232	1.791	0.434	135	5.9	45.5	11.0	100
TOPS 047034-L	yellow	1.339	1.831	0.625	90	34.0	46.5	15.9	50
TOPS 075015-L	yellow	0.791	2.933	0.706	90	20.1	74.5	17.9	50
TOPS 090034-L	yellow	1.348	3.544	1.180	120	34.2	90	30	25

Current pricing and additional sizes available at [www.epsi.com](http://www.epsi.com)

Not all sizes are available in all warehouse locations - please check with your local sales rep for lead time and availability



## Washer Plugs

Heat resistant up to 600°F (315°C)

Material: Silicone

Duro: 55 +/- 5 Shore

- » When plugging a hole, make sure the major diameter of the plug is 2-4% larger than the diameter of the hole
- » Twisting the plug as it is inserted will aid in installation
- » Silicone plugs are not recommended for exposure to aggressive chemicals or hydrocarbons
- » Tapered design for easy insertion
- » Washer masks grounding area around holes
- » One plug can be used to plug two different hole diameters
- » Second plug acts as a handle

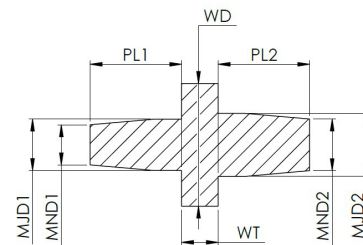

Current pricing and additional sizes available at [www.epsi.com](http://www.epsi.com)

Not all sizes are available in all warehouse locations - please check with your local sales rep for lead time and availability

# WP

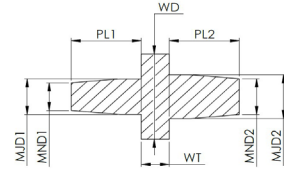

Part number	Color	MJD1 (in)	MJD2 (in)	MND1 (in)	MND2 (in)	PL1 (in)	PL2 (in)	WD (in)	WT (in)	MJD1 (mm)	MJD2 (mm)	MND1 (mm)	MND2 (mm)	PL1 (mm)	PL2 (mm)	WD (mm)	WT (mm)	pcs/bag
WP103-250-130	clear	0.103	0.130	0.069	0.103	0.500	0.500	0.250	0.200	2.6	3.3	1.8	2.6	12.7	12.7	6.4	5.1	1000
WP130-250-140	clear	0.130	0.140	0.069	0.079	0.500	0.500	0.250	0.200	3.3	3.6	1.8	2.0	12.7	12.7	6.4	5.1	1000
WP130-250-200	clear	0.130	0.200	0.069	0.139	0.500	0.500	0.250	0.200	3.3	5.1	1.8	3.5	12.7	12.7	6.4	5.1	1000
WP130-312-155	clear	0.130	0.155	0.069	0.094	0.500	0.500	0.312	0.200	3.3	3.9	1.8	2.4	12.7	12.7	7.9	5.1	1000
WP130-500-375	clear	0.130	0.375	0.069	0.314	0.500	0.500	0.500	0.200	3.3	9.5	1.8	8.0	12.7	12.7	12.7	5.1	250
WP140-250-180	clear	0.140	0.180	0.079	0.119	0.500	0.500	0.250	0.200	3.6	4.6	2.0	3.0	12.7	12.7	6.4	5.1	1000
WP140-375-200	clear	0.140	0.200	0.079	0.139	0.500	0.500	0.375	0.200	3.6	5.1	2.0	3.5	12.7	12.7	9.5	5.1	500
WP140-500-180	clear	0.140	0.180	0.079	0.119	0.500	0.500	0.500	0.200	3.6	4.6	2.0	3.0	12.7	12.7	12.7	5.1	250
WP140-625-250	clear	0.140	0.250	0.079	0.189	0.500	0.500	0.625	0.200	3.6	6.4	2.0	4.8	12.7	12.7	15.9	5.1	250
WP155-250-200	clear	0.155	0.200	0.094	0.139	0.500	0.500	0.250	0.200	3.9	5.1	2.4	3.5	12.7	12.7	6.4	5.1	1000
WP155-250-238	clear	0.155	0.238	0.094	0.177	0.500	1.500	0.250	0.200	3.9	6.0	2.4	4.5	12.7	12.7	6.4	5.1	1000
WP155-312-238	clear	0.155	0.238	0.094	0.177	0.500	0.500	0.312	0.200	3.9	6.0	2.4	4.5	12.7	12.7	7.9	5.1	1000
WP155-375-238	clear	0.155	0.238	0.094	0.177	0.500	0.500	0.375	0.200	3.9	6.0	2.4	4.5	12.7	12.7	9.5	5.1	500
WP155-500-390	clear	0.155	0.390	0.094	0.329	0.500	0.500	0.500	0.200	3.9	9.9	2.4	8.4	12.7	12.7	12.7	5.1	250
WP180-250-180	clear	0.180	0.180	0.119	0.119	0.500	0.500	0.250	0.200	4.6	4.6	3.0	3.0	12.7	12.7	6.4	5.1	1000
WP180-350-225	clear	0.180	0.225	0.119	0.164	0.500	0.500	0.350	0.200	4.6	5.7	3.0	4.2	12.7	12.7	8.9	5.1	500
WP180-375-200	clear	0.180	0.200	0.119	0.139	0.500	0.500	0.375	0.200	4.6	5.1	3.0	3.5	12.7	12.7	9.5	5.1	500
WP180-250-238	clear	0.180	0.238	0.119	0.177	0.500	0.500	0.250	0.200	4.6	6.0	3.0	4.5	12.7	12.7	6.0	5.1	1000
WP180-500-200	clear	0.180	0.200	0.119	0.139	0.500	0.500	0.500	0.200	4.6	5.1	3.0	3.5	12.7	12.7	12.7	5.1	250
WP180-500-238	clear	0.180	0.238	0.119	0.238	0.500	0.500	0.500	0.200	4.6	6.0	3.0	6.0	12.7	12.7	12.7	5.1	250
WP200-250-238	clear	0.200	0.238	0.139	0.177	0.500	0.500	0.250	0.200	5.1	6.0	3.5	4.5	12.7	12.7	6.4	5.1	1000
WP200-312-238	clear	0.200	0.238	0.139	0.177	0.500	0.500	0.312	0.200	5.1	6.0	3.5	4.5	12.7	12.7	7.9	5.1	1000
WP200-312-275	clear	0.200	0.275	0.139	0.275	0.500	0.500	0.312	0.200	5.1	7.0	3.5	7.0	12.7	12.7	7.9	5.1	1000
WP200-375-275	clear	0.200	0.275	0.139	0.214	0.500	0.500	0.375	0.200	5.1	7.0	3.5	5.4	12.7	12.7	9.5	5.1	500
WP209-375-275	clear	0.209	0.275	0.148	0.214	0.500	0.500	0.375	0.200	5.3	7.0	3.8	5.4	12.7	12.7	9.5	5.1	500
WP218-716-281	clear	0.218	0.281	0.157	0.220	0.500	0.500	0.716	0.200	5.5	7.1	4.0	5.5	12.7	12.7	18.2	5.1	100
WP238-375-250	clear	0.238	0.250	0.177	0.189	0.500	0.500	0.375	0.200	6.0	6.4	4.5	4.8	12.7	12.7	9.5	5.1	500
WP238-500-250	clear	0.238	0.250	0.119	0.177	0.500	0.500	0.500	0.200	6.0	6.4	3.0	4.5	12.7	12.7	12.7	5.1	250
WP265-1180-515	clear	0.265	0.515	0.204	0.454	0.500	0.500	1.180	0.200	6.7	13.1	5.1	11.5	12.7	12.7	30.0	5.1	50
WP265-1180-640	clear	0.265	0.640	0.204	0.579	0.500	0.500	1.180	0.200	6.7	16.3	5.1	14.7	12.7	12.7	30.0	5.1	50
WP275-375-375	clear	0.275	0.375	0.177	0.189	0.500	0.500	0.375	0.200	7.0	9.5	4.5	4.8	12.7	12.7	9.5	5.1	500
WP275-500-375	clear	0.275	0.375	0.214	0.314	0.500	0.500	0.500	0.200	7.0	9.5	5.4	8.0	12.7	12.7	12.7	5.1	250
WP331-787-331	clear	0.331	0.331	0.270	0.270	0.500	0.500	0.787	0.200	8.4	8.4	6.9	6.9	12.7	12.7	20.0	5.1	100
WP346-625-413	clear	0.346	0.413	0.291	0.354	0.500	0.500	0.625	0.200	8.8	10.5	7.4	9.0	12.7	12.7	15.9	5.1	250
WP350-500-420	clear	0.350	0.420	0.289	0.359	0.500	0.500	0.500	0.200	8.9	10.7	7.3	9.1	12.7	12.7	12.7	5.1	250
WP375-500-455	clear	0.455	0.375	0.394	0.314	0.500	0.500	0.500	0.200	11.6	9.5	10.0	8.0	12.7	12.7	12.7	5.1	100
WP375-787-512	clear	0.375	0.512	0.314	0.512	0.500	0.500	0.787	0.200	9.5	13.0	8.0	13.0	12.7	12.7	20.0	5.1	100
WP390-500-455	clear	0.390	0.455	0.329	0.394	0.500	0.500	0.500	0.200	9.9	11.6	8.4	10.0	12.7	12.7	12.7	5.1	250
WP551-787-551	clear	0.551	0.551	0.490	0.490	0.500	0.500	0.787	0.200	14.0	14.0	12.4	12.4	12.7	12.7	20.0	5.1	100
WP551-787-689	clear	0.551	0.689	0.490	0.628	0.500	0.500	0.787	0.200	14.0	17.5	12.4	16.0	12.7	12.7	20.0	5.1	100
WP551-944-708	clear	0.551	0.708	0.490	0.647	0.500	0.500	0.944	0.200	14.0	18.0	12.4	16.4	12.7	12.7	24.0	5.1	100

Current pricing and additional sizes available at [www.epsi.com](http://www.epsi.com)

Not all sizes are available in all warehouse locations - please check with your local sales rep for lead time and availability





# TPSP

## Port-Tite Plugs



Heat resistant up to 185°F (85°C)

Material: Polyethylene Plug with Integrated Flange and NBR O-Ring

- » Innovative: Effectively masks threads as well as protects during shipping/handling
- » Self-Sealing: Integrated flange and NBR O-ring provide liquid and air tight seal
- » Fast and Easy: Install/remove by hand, socket, wrench, or #2 phillips head screwdriver
- » Durable: High-density polyethylene stands up to repeated use
- » Ideal Solution: Flange and O-ring make Port-Tite perfect for plating applications

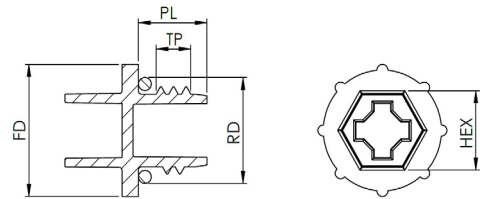

Part number	Color	TP (in)	PL (in)	RD (in)	FD (in)	HEX (in)	TP (mm)	PL (mm)	RD (mm)	FD (mm)	HEX (mm)	pcs/bag
TPSP-00563	green	9/16-18	0.432	0.621	0.707	1/2	14.3	11.0	15.8	18.0	12.7	1500
TPSP-00750	green	3/4-16	0.523	0.783	0.889	5/8	19.0	13.3	20.0	22.5	15.8	750
TPSP-00875	green	7/8-14	0.576	0.889	1.020	3/4	22.2	14.6	22.6	25.9	19.0	400
TPSP-01063	green	1-1/16-12	0.668	1.076	1.227	7/8	27.0	17.0	27.3	31.2	22.2	300
TPSP-01313	green	1-5/16-12	0.710	1.321	1.563	1-1/16	33.3	18.0	33.6	39.7	27.0	350
TPSP-01875	green	1-7/8-12	0.775	1.874	2.074	1-1/2	47.6	20.0	47.6	52.7	38.1	100
TPSP-M0472	green	M12x1.75	0.352	0.555	0.600	M6	X	9.0	14.1	15.2	X	2000
TPSP-M0551	green	M14x1.5	0.352	0.610	0.630	M6	X	9.0	15.5	16.0	X	1500
TPSP-M0630	green	M16x1.5	0.512	0.689	0.770	M8	X	13.0	17.5	19.6	X	1000
TPSP-M0709	green	M18x1.5	0.523	0.783	0.900	M10	X	13.3	19.9	22.9	X	500
TPSP-M0866	green	M22x1.5	0.523	0.899	0.960	M10	X	13.3	22.6	24.4	X	500
TPSP-M1063	green	M27x2	0.668	1.076	1.350	M16	X	17.0	27.3	34.5	X	600
TPSP-01625	green	1-5/8-12	0.660	1.693	2.17	1-1/16	X	16.8	43.0	55.1	X	100

Current pricing and additional sizes available at [www.epsi.com](http://www.epsi.com)

Not all sizes are available in all warehouse locations - please check with your local sales rep for lead time and availability



# HTP



## Hang-Tite Plugs

Heat resistant up to 600°F (315°C)

Material: Silicone + Metal

Duro: 55 +/- 5 Shore

- » Durable: Cold rolled steel insert and high temp commercial grade silicone to withstand repeated use. It can be made custom upon request
- » Versatile: Provides a liquid-tight seal in immersion processes, while allowing conductivity to your part
- » Convenient: Hangs heavier parts and seals off the first thread, or chamfer of the hole at the same time
- » Custom sizes available upon request

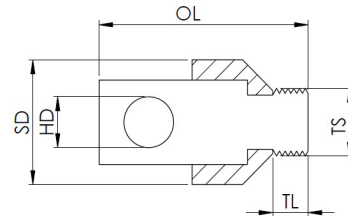

Part number	Color	C/F	TS (in)	TL (in)	HD (in)	OL (in)	SD (in)	TS (mm)	TL (mm)	HD (mm)	OL (mm)	SD (mm)	pcs/bag
HTP 14-20	white	Coarse	1/4-20	0.175	0.197	0.870	0.483	X	4.5	5.0	22.1	12.3	20
HTP 516-18	pink	Coarse	5/16-18	0.197	0.236	1.023	0.569	X	5.0	6.0	26.0	14.5	20
HTP 38-16	gray	Coarse	3/8-16	0.222	0.236	1.047	0.624	X	5.6	6.0	26.6	15.8	20
HTP 12-13	black	Coarse	1/2-13	0.276	0.276	1.101	0.745	X	7.0	7.0	28.0	18.9	20
HTP M06	blue	Coarse	M6X1	0.141	0.197	0.836	0.479	X	3.5	5.0	21.2	12.2	20
HTP M08	yellow	Coarse	M8X1.25	0.169	0.236	0.994	0.580	X	4.3	6.0	25.2	15.0	20
HTP M10	rusty	Coarse	M10X1.5	0.210	0.236	1.035	0.646	X	5.3	6.0	26.3	16.4	20
HTP M12	red	Coarse	M12X1.75	0.251	0.275	1.076	0.725	X	6.4	7.0	27.3	18.4	20

Current pricing and additional sizes available at [www.epsi.com](http://www.epsi.com)

Not all sizes are available in all warehouse locations - please check with your local sales rep for lead time and availability

# TCP



## Tapered Cap & Plug

Heat resistant up to 185°F (85°C)

Material: Polyethylene

- » Versatile: Effectively masks as a cap or plug in a wide variety of applications
- » Protective: Keeps parts free from contaminants and debris during handling and storage
- » Fast and Easy: Quick to install and remove by hand
- » Economical: Inexpensive enough for one-time use, yet durable enough for repeated use

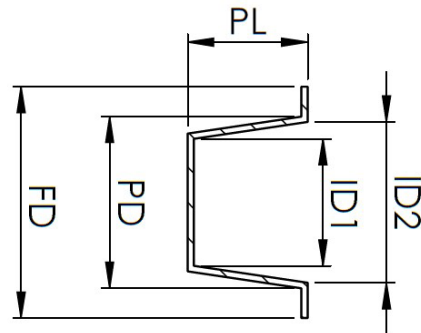

Current pricing and additional sizes available at [www.epsi.com](http://www.epsi.com)

Not all sizes are available in all warehouse locations - please check with your local sales rep for lead time and availability

# TCP

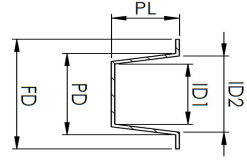

Part number	Color	PD (in)	PL (in)	FD (in)	ID1 (in)	ID2 (in)	PD (mm)	PL (mm)	FD (mm)	ID1 (mm)	ID2 (mm)	pcs/bag
TCP 0182X0380	blue	0.180	0.220	0.310	0.088	0.140	4.6	5.6	7.9	2.2	3.6	1000
TCP 0180X0220	blue	0.182	0.380	0.310	0.053	0.116	4.6	9.7	7.9	1.3	2.9	1000
TCP 0205X0380	blue	0.205	0.380	0.410	0.079	0.145	5.2	9.7	10.4	2.0	3.7	1000
TCP 0240X0380	blue	0.240	0.380	0.380	0.111	0.173	6.1	9.7	9.7	2.8	4.4	1000
TCP 0255X0380	blue	0.255	0.380	0.380	0.113	0.184	6.5	9.7	9.7	2.9	4.7	1000
TCP 0269X0310	blue	0.269	0.310	0.380	0.150	0.209	6.8	7.9	9.7	3.8	5.3	3000
TCP 0275X0310	blue	0.275	0.310	0.450	0.146	0.210	7.0	7.9	11.4	3.7	5.3	2000
TCP 0302X0380	blue	0.302	0.380	0.440	0.174	0.236	7.7	9.7	11.2	4.4	6.0	1000
TCP 0335X0380	blue	0.335	0.380	0.470	0.205	0.267	8.5	9.7	11.9	5.2	6.8	1000
TCP 0365X0380	blue	0.365	0.380	0.500	0.235	0.299	9.3	9.7	12.7	6.0	7.6	1000
TCP 0367X0190	blue	0.367	0.190	0.500	0.263	0.325	9.3	4.8	12.7	6.7	8.3	1000
TCP 0396X0380	blue	0.396	0.380	0.530	0.267	0.330	10.1	9.7	13.5	6.8	8.4	1000
TCP 0427X0380	blue	0.427	0.380	0.560	0.298	0.361	10.8	9.7	14.2	7.6	9.2	1000
TCP 0456X0380	blue	0.456	0.380	0.590	0.327	0.390	11.6	9.7	15.0	8.3	9.9	1000
TCP 0485X0380	blue	0.485	0.380	0.630	0.356	0.419	12.3	9.7	16.0	9.0	10.6	1000
TCP 0513X0380	blue	0.513	0.380	0.660	0.385	0.447	13.0	9.7	16.8	9.8	11.4	1000
TCP 0547X0280	blue	0.547	0.280	0.690	0.415	0.477	13.9	7.1	17.5	10.5	12.1	1500
TCP 0547X0440	blue	0.547	0.440	0.690	0.409	0.471	13.9	11.2	17.5	10.4	12.0	1000
TCP 0562X0220	blue	0.562	0.220	0.680	0.477	0.533	14.3	5.6	17.3	12.1	13.5	1000
TCP 0576X0440	blue	0.576	0.440	0.720	0.440	0.500	14.6	11.2	18.3	11.2	12.7	1000
TCP 0608X0440	blue	0.608	0.440	0.750	0.468	0.532	15.4	11.2	19.1	11.9	13.5	1000
TCP 0631X0470	blue	0.631	0.470	0.750	0.487	0.550	16.0	11.9	19.1	12.4	14.0	1000
TCP 0667X0500	blue	0.667	0.500	0.810	0.518	0.580	16.9	12.7	20.6	13.2	14.7	1000
TCP 0694X0190	blue	0.694	0.190	0.750	0.613	0.669	17.6	4.8	19.1	15.6	17.0	1000
TCP 0695X0500	blue	0.695	0.500	0.840	0.549	0.610	17.7	12.7	21.3	13.9	15.5	1000
TCP 0727X0500	blue	0.727	0.500	0.880	0.578	0.640	18.5	12.7	22.4	14.7	16.3	1000
TCP 0755X0500	blue	0.755	0.500	0.880	0.613	0.675	19.2	12.7	22.4	15.6	17.1	1000
TCP 0765X0190	blue	0.765	0.190	0.880	0.678	0.740	19.4	4.8	22.4	17.2	18.8	1000
TCP 0788X0560	blue	0.788	0.560	0.940	0.628	0.690	20.0	14.2	23.9	16.0	17.5	1000
TCP 0805X0160	blue	0.805	0.160	0.860	0.688	0.750	20.4	4.1	21.8	17.5	19.1	1500
TCP 0823X0560	blue	0.823	0.560	0.970	0.663	0.725	20.9	14.2	24.6	16.8	18.4	1000
TCP 0848X0560	blue	0.848	0.560	1.000	0.687	0.750	21.5	14.2	25.4	17.4	19.1	1000
TCP 0848X0390	blue	0.848	0.390	1.020	0.687	0.748	21.5	9.9	25.9	17.4	19.0	1000
TCP 0890X0220	blue	0.890	0.220	1.050	0.757	0.837	22.6	5.6	26.7	19.2	21.3	1000
TCP 0911X0630	blue	0.911	0.630	1.060	0.740	0.802	23.1	16.0	26.9	18.8	20.4	500
TCP 0930X0630	blue	0.930	0.630	1.090	0.753	0.815	23.6	16.0	27.7	19.1	20.7	500
TCP 0973X0720	blue	0.973	0.720	1.130	0.805	0.869	24.7	18.3	28.7	20.4	22.1	500
TCP 0975X0630	blue	0.975	0.630	1.130	0.803	0.866	24.8	16.0	28.7	20.4	22.0	500
TCP 1040X0470	blue	1.040	0.470	1.160	0.895	0.955	26.4	11.9	29.5	22.7	24.3	700

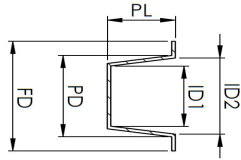

# TCP

Part number	Color	PD (in)	PL (in)	FD (in)	ID1 (in)	ID2 (in)	PD (mm)	PL (mm)	FD (mm)	ID1 (mm)	ID2 (mm)	pcs/bag
TCP 1040X0690	blue	1.040	0.690	1.160	0.855	0.915	26.4	17.5	29.5	21.7	23.2	500
TCP 1040X0840	blue	1.040	0.840	1.310	0.940	1.020	26.4	21.3	33.3	23.9	25.9	300
TCP 1047X0500	blue	1.047	0.500	1.190	0.900	0.960	26.6	12.7	30.2	22.9	24.4	1000
TCP 1090X0750	blue	1.090	0.750	1.250	0.901	0.964	27.7	19.1	31.8	22.9	24.5	500
TCP 1090X1000	blue	1.090	1.000	1.250	0.890	0.950	27.7	25.4	31.8	22.6	24.1	300
TCP 1104X0720	blue	1.104	0.720	1.440	0.918	0.975	28.0	18.3	36.6	23.3	24.8	400
TCP 1145X0750	blue	1.145	0.750	1.310	0.933	0.995	29.1	19.1	33.3	23.7	25.3	500
TCP 1215X0750	blue	1.215	0.750	1.410	1.031	1.094	30.9	19.1	35.8	26.2	27.8	500
TCP 1284X0630	blue	1.284	0.630	1.440	1.113	1.175	32.6	16.0	36.6	28.3	29.8	500
TCP 1284X1670	blue	1.284	0.630	1.670	1.113	1.175	32.6	16.0	42.4	28.3	29.8	400
TCP 1305X1060	blue	1.305	1.060	1.430	0.777	0.836	33.1	26.9	36.3	19.7	21.2	500
TCP 1312X0500	blue	1.312	0.500	1.380	1.155	1.276	33.3	12.7	35.1	29.3	32.4	400
TCP 1346X0380	blue	1.346	0.380	1.470	1.227	1.285	34.2	9.7	37.3	31.2	32.6	500
TCP 1355X0750	blue	1.355	0.750	1.500	1.161	1.224	34.4	19.1	38.1	29.5	31.1	400
TCP 1356X0720	blue	1.356	0.720	1.500	1.231	1.292	34.4	18.3	38.1	31.3	32.8	300
TCP 1360X0810	blue	1.360	0.810	1.500	1.173	1.235	34.5	20.6	38.1	29.8	31.4	400
TCP 1420X0810	blue	1.420	0.810	1.560	1.085	1.140	36.1	20.6	39.6	27.6	29.0	500
TCP 1465X0390	blue	1.465	0.500	1.620	1.286	1.395	37.2	12.7	41.1	32.7	35.4	200
TCP 1465X0500	blue	1.465	0.500	1.620	1.286	1.350	37.2	12.7	41.1	32.7	34.3	400
TCP 1465X0720	blue	1.465	0.720	1.620	1.248	1.312	37.2	18.3	41.1	31.7	33.3	300
TCP 1465X0880	blue	1.465	0.880	1.630	1.249	1.312	37.2	22.4	41.4	31.7	33.3	300
TCP 1500X0750	blue	1.500	0.750	1.750	1.340	1.435	38.1	19.1	44.5	34.0	36.4	200
TCP 1507X0750	blue	1.507	0.750	1.630	1.169	1.239	38.3	19.1	41.4	29.7	31.5	500
TCP 1507X0910	blue	1.507	0.910	1.770	1.282	1.344	38.3	23.1	45.0	32.6	34.1	200
TCP 1600X0500	blue	1.600	0.500	1.750	1.451	1.513	40.6	12.7	44.5	36.9	38.4	500
TCP 1600X0880	blue	1.600	0.880	1.750	1.384	1.447	40.6	22.4	44.5	35.2	36.8	200
TCP 1601X0720	blue	1.601	0.720	1.750	1.387	1.451	40.7	18.3	44.5	35.2	36.9	200
TCP 1602X0720	blue	1.602	0.720	1.750	1.455	1.519	40.7	18.3	44.5	37.0	38.6	300
TCP 1682X0750	blue	1.682	0.750	1.880	1.498	1.560	42.7	19.1	47.8	38.0	39.6	200
TCP 1688X0620	blue	1.688	0.620	1.880	1.514	1.574	42.9	15.7	47.8	38.5	40.0	300
TCP 1750X0690	blue	1.750	0.690	1.840	1.569	1.633	44.5	17.5	46.7	39.9	41.5	200
TCP 1750X0750	blue	1.750	0.750	1.940	1.568	1.630	44.5	19.1	49.3	39.8	41.4	200
TCP 1805X0380	blue	1.805	0.380	2.000	1.722	1.781	45.8	9.7	50.8	43.7	45.2	200
TCP 1850X0720	blue	1.850	0.720	2.030	1.664	1.720	47.0	18.3	51.6	42.3	43.7	300
TCP 1880X0750	blue	1.880	0.750	2.000	1.688	1.750	47.8	19.1	50.8	42.9	44.5	200
TCP 1895X1280	blue	1.895	1.280	2.060	1.378	1.440	48.1	32.5	52.3	35.0	36.6	200
TCP 1938X0970	blue	1.938	0.970	2.160	1.743	1.807	49.2	24.6	54.9	44.3	45.9	200
TCP 1950X0100	blue	1.950	1.000	2.130	1.718	1.780	49.5	25.4	54.1	43.6	45.2	200
TCP 1950X1000	blue	1.950	1.000	2.130	1.718	1.780	49.5	25.4	54.1	43.6	45.2	200

# TCP

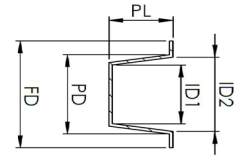

Part number	Color	PD (in)	PL (in)	FD (in)	ID1 (in)	ID2 (in)	PD (mm)	PL (mm)	FD (mm)	ID1 (mm)	ID2 (mm)	pcs/bag
TCP 1975X0630	blue	1.975	0.630	2.380	1.785	1.865	50.2	16.0	60.5	45.3	47.4	250
TCP 2000X1000	blue	2.000	1.000	2.130	1.781	1.844	50.8	25.4	54.1	45.2	46.8	160
TCP 2065X0720	blue	2.065	0.720	2.200	1.885	1.950	52.5	18.3	55.9	47.9	49.5	250
TCP 2076X1000	blue	2.076	1.000	2.250	1.837	1.900	52.7	25.4	57.2	46.7	48.3	150
TCP 2100X0340	blue	2.100	0.340	2.590	2.060	2.020	53.3	8.6	65.8	52.3	51.3	200
TCP 2132X1000	blue	2.132	1.000	2.250	1.913	1.975	54.2	25.4	57.2	48.6	50.2	150
TCP 2147X0750	blue	2.147	0.750	2.310	1.953	2.015	54.5	19.1	58.7	49.6	51.2	200
TCP 2163X1180	blue	2.163	1.180	2.310	1.668	1.738	54.9	30.0	58.7	42.4	44.1	200
TCP 2243X1000	blue	2.243	1.000	2.440	2.005	2.067	57.0	25.4	62.0	50.9	52.5	150
TCP 2260X0500	blue	2.260	0.500	2.500	2.168	2.230	57.4	12.7	63.5	55.1	56.6	200
TCP 2310X0850	blue	2.310	0.850	2.470	1.875	1.935	58.7	21.6	62.7	47.6	49.1	200
TCP 2312X1000	blue	2.312	1.000	2.560	2.074	2.136	58.7	25.4	65.0	52.7	54.3	150
TCP 2400X0720	blue	2.400	0.720	2.800	2.216	2.280	61.0	18.3	71.1	56.3	57.9	150
TCP 2125X1000	blue	2.406	1.000	2.530	2.063	2.125	61.1	25.4	64.3	52.4	54.0	150
TCP 2464X1000	blue	2.464	1.000	2.630	2.235	2.298	62.6	25.4	66.8	56.8	58.4	100
TCP 2464X0720	blue	2.464	0.720	2.660	2.220	2.300	62.6	18.3	67.6	56.4	58.4	400
TCP 2602X1030	blue	2.602	1.030	2.810	2.333	2.395	66.1	26.2	71.4	59.3	60.8	100
TCP 2604X1130	blue	2.604	1.130	2.810	2.332	2.396	66.1	28.7	71.4	59.2	60.9	100
TCP 2644X0630	blue	2.644	0.630	2.780	2.418	2.480	67.2	16.0	70.6	61.4	63.0	200
TCP 2650X0960	blue	2.650	0.960	2.780	2.247	2.311	67.3	24.4	70.6	57.1	58.7	400
TCP 2650X1250	blue	2.650	1.250	2.780	2.245	2.307	67.3	31.8	70.6	57.0	58.6	100
TCP 2690X0630	blue	2.690	0.630	2.880	2.493	2.555	68.3	16.0	73.2	63.3	64.9	200
TCP 2690X0720	blue	2.690	0.720	2.880	2.497	2.561	68.3	18.3	73.2	63.4	65.0	100
TCP 2750X1000	blue	2.750	1.000	2.880	2.395	2.457	69.9	25.4	73.2	60.8	62.4	100
TCP 2788X0470	blue	2.788	0.470	2.970	2.595	2.655	70.8	11.9	75.4	65.9	67.4	200
TCP 2790X0750	blue	2.790	0.750	2.940	2.579	2.641	70.9	19.1	74.7	65.5	67.1	100
TCP 2870X0710	blue	2.870	0.710	3.060	2.626	2.706	72.9	18.0	77.7	66.7	68.7	100
TCP 2980X0750	blue	2.980	0.750	3.250	2.787	2.849	75.7	19.1	82.6	70.8	72.4	100
TCP 2990X1000	blue	2.990	1.000	3.130	2.656	2.720	75.9	25.4	79.5	67.5	69.1	100
TCP 2990X2760	blue	2.990	1.000	3.130	2.656	2.720	75.9	25.4	79.5	67.5	69.1	100
TCP 3103X0750	blue	3.103	0.750	3.340	2.915	2.975	78.8	19.1	84.8	74.0	75.6	100
TCP 3159X0470	blue	3.159	0.470	3.410	2.916	2.996	80.2	11.9	86.6	74.1	76.1	100
TCP 3245X1000	blue	3.245	1.000	3.380	2.912	2.982	82.4	25.4	85.9	74.0	75.7	100
TCP 3370X1000	blue	3.370	1.000	3.500	3.020	3.090	85.6	25.4	88.9	76.7	78.5	100
TCP 3457X0750	blue	3.457	0.750	3.630	3.245	3.325	87.8	19.1	92.2	82.4	84.5	120
TCP 3562X1130	blue	3.562	1.130	3.690	3.200	3.270	90.5	28.7	93.7	81.3	83.1	50
TCP 3600X0750	blue	3.600	0.750	3.880	3.410	3.470	91.4	19.1	98.6	86.6	88.1	100
TCP 3730X1000	blue	3.730	1.000	4.000	3.480	3.550	94.7	25.4	101.6	88.4	90.2	60
TCP 3800X0750	blue	3.800	0.750	4.000	3.610	3.680	96.5	19.1	101.6	91.7	93.5	90

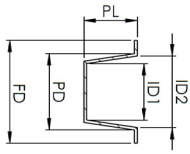

# TCP

Part number	Color	PD (in)	PL (in)	FD (in)	ID1 (in)	ID2 (in)	PD (mm)	PL (mm)	FD (mm)	ID1 (mm)	ID2 (mm)	pcs/bag
TCP 3920X0750	blue	3.920	0.750	4.120	3.710	3.790	99.6	19.1	104.6	94.2	96.3	60
TCP 4070X0750	blue	4.070	0.750	4.380	3.860	3.930	103.4	19.1	111.3	98.0	99.8	90
TCP 4140X0750	blue	4.140	0.750	4.530	3.940	4.020	105.2	19.1	115.1	100.1	102.1	90
TCP 4320X1250	blue	4.320	1.250	4.620	4.010	4.090	109.7	31.8	117.3	101.9	103.9	60
TCP 4430X0880	blue	4.430	0.880	4.880	4.180	4.270	112.5	22.4	124.0	106.2	108.5	50
TCP 4459X0960	blue	4.459	0.960	4.940	4.134	4.214	113.3	24.4	125.5	105.0	107.0	80
TCP 4620X1000	blue	4.620	1.000	5.000	4.290	4.370	117.3	25.4	127.0	109.0	111.0	50
TCP 4850X0880	blue	4.850	0.880	5.250	4.570	4.640	123.2	22.4	133.4	116.1	117.9	50
TCP 4970X1000	blue	4.970	1.000	5.380	4.710	4.790	126.2	25.4	136.7	119.6	121.7	50
TCP 5090X1000	blue	5.090	1.000	5.500	4.830	4.910	129.3	25.4	139.7	122.7	124.7	50
TCP 5100X0680	blue	5.100	0.680	5.440	4.900	4.980	129.5	17.3	138.2	124.5	126.5	90
TCP 5200X1000	blue	5.200	1.000	5.630	4.920	4.990	132.1	25.4	143.0	125.0	126.7	50
TCP 5360X1000	blue	5.360	1.000	5.880	5.110	5.180	136.1	25.4	149.4	129.8	131.6	50
TCP 5490X0880	blue	5.490	0.880	5.880	5.210	5.330	139.4	22.4	149.4	132.3	135.4	50
TCP 5620X1000	blue	5.620	1.000	6.130	5.390	5.470	142.7	25.4	155.7	136.9	138.9	50
TCP 5750X1000	blue	5.750	1.000	6.190	5.490	5.570	146.1	25.4	157.2	139.4	141.5	50
TCP 5870X0980	blue	5.870	0.980	6.250	5.610	5.700	149.1	24.9	158.8	142.5	144.8	50
TCP 6180X1000	blue	6.180	1.000	6.620	5.920	6.010	157.0	25.4	168.1	150.4	152.7	50
TCP 6350X1000	blue	6.350	1.000	6.750	6.090	6.180	161.3	25.4	171.5	154.7	157.0	20
TCP 6560X0870	blue	6.560	0.870	6.940	6.330	6.400	166.6	22.1	176.3	160.8	162.6	20
TCP 6710X1500	blue	6.710	1.500	7.190	6.530	6.610	170.4	38.1	182.6	165.9	167.9	20
TCP 6774X1500	blue	6.774	1.500	7.190	6.562	6.668	172.1	38.1	182.6	166.7	169.4	20
TCP 7030X0500	blue	7.030	0.500	7.670	6.800	6.880	178.6	12.7	194.8	172.7	174.8	20
TCP 7120X1040	blue	7.120	1.040	7.630	6.970	7.050	180.8	26.4	193.8	177.0	179.1	20
TCP 7358X1460	blue	7.358	1.460	7.720	6.851	6.943	186.9	37.1	196.1	174.0	176.4	16
TCP 7650X1000	blue	7.650	1.000	7.940	7.260	7.340	194.3	25.4	201.7	184.4	186.4	20
TCP 7840X1000	blue	7.840	1.000	8.120	7.580	7.660	199.1	25.4	206.2	192.5	194.6	20
TCP 8140X1000	blue	8.140	1.000	8.380	7.880	7.970	206.8	25.4	212.9	200.2	202.4	20
TCP 8350X1380	blue	8.350	1.380	8.750	8.050	8.150	212.1	35.1	222.3	204.5	207.0	10
TCP 8600X1380	blue	8.600	1.380	9.000	8.300	8.400	218.4	35.1	228.6	210.8	213.4	10
TCP 8730X1500	blue	8.730	1.500	9.130	8.550	8.670	221.7	38.1	231.9	217.2	220.2	10
TCP 9364X1750	blue	9.364	1.750	9.860	8.890	9.060	237.8	44.5	250.4	225.8	230.1	10
TCP 10290X1500	blue	10.220	0.970	10.560	9.820	9.970	259.6	24.6	268.2	249.4	253.2	12
TCP 10220X0970	blue	10.290	1.500	10.560	9.770	9.900	261.4	38.1	268.2	248.2	251.5	15
TCP 11098X1750	blue	11.098	1.750	11.600	10.620	10.790	281.9	44.5	294.6	269.7	274.1	8
TCP 11455X2000	blue	11.455	2.000	11.960	10.779	11.110	291.0	50.8	303.8	273.8	282.2	8
TCP 13138X2000	blue	13.597	2.000	14.100	12.960	13.250	345.4	50.8	358.1	329.2	336.6	6
TCP 13597X2000	blue	13.597	2.000	14.100	12.960	13.250	345.4	50.8	358.1	329.2	336.6	6

Current pricing and additional sizes available at [www.epsi.com](http://www.epsi.com)

Not all sizes are available in all warehouse locations - please check with your local sales rep for lead time and availability



# NTS



## Neoprene Tapered Stopper

Heat resistant up to 600°F (315°C)

Material: Neoprene

Duro: 55 +/- 5 Shore

- » For the best fit, match the hole diameter to the plug midpoint diameter
- » Silicone Tapered Stoppers are not recommended for exposure to aggressive chemicals or hydrocarbons
- » Tapered design to fit a variety of hole diameters
- » Compressible for better sealing of both threaded and non-threaded holes

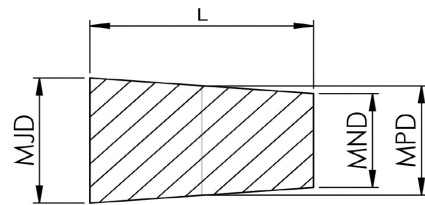

Part number	Color	MJD (in)	MND (in)	MPD (in)	OL (in)	MJD (mm)	MND (mm)	MPD (mm)	OL (mm)	pcs/bag
NTS 0125X0625-G	green	0.125	0.062	0.094	0.063	3.18	1.574	2.387	1.6	1000
NTS 0187X0750-G	green	0.187	0.062	0.125	0.750	4.75	1.574	3.18	19.0	1000
NTS 0250X0750-G	green	0.250	0.125	0.188	0.750	6.35	3.18	4.78	19.0	1000
NTS 0343X0625-G	green	0.343	0.187	0.265	0.063	8.71	4.75	6.73	1.6	1000
NTS 0375X0750-G	green	0.375	0.250	0.313	0.750	9.52	6.35	7.95	19.0	500
NTS 0472X0748-G	green	0.472	0.354	0.413	0.748	11.98	9.0	10.5	19.0	500
NTS 0591X0748-G	green	0.591	0.433	0.512	0.748	15.01	11.0	13.0	19.0	250
NTS 0656X1000-G	green	0.656	0.500	0.578	1.000	16.66	12.7	14.7	25.4	250
NTS 0748X1000-G	green	0.748	0.550	0.649	1.000	19.0	14.0	16.5	25.4	250
NTS 0787X1000-G	green	0.787	0.630	0.709	1.000	20.0	16.0	18.0	25.4	100
NTS 0938X1000-G	green	0.938	0.708	0.823	1.000	23.8	18.0	20.9	25.4	100
NTS 1062X0984-G	green	1.062	0.866	0.964	0.984	27.0	22.0	25.0	24.9	100
NTS 1250X1000-G	green	1.250	1.024	-	1.000	31.75	26.0	-	25.4	100

Current pricing and additional sizes available at [www.epsi.com](http://www.epsi.com)

Not all sizes are available in all warehouse locations - please check with your local sales rep for lead time and availability





# Custom Masking



Are you spending too much on masking labor?  
Is your line speed suffering due to complicated masking?  
Do you want to reduce your 3P cost (per painted part)?  
If so, custom masking from EPSI is for you!

EPSI is proud to offer custom silicone masks. Our in-house engineering team possesses over a decade of experience in partnering with clients towards the production of tens of thousands of custom silicone masks.

We continually lead the industry in creating efficient, custom solutions that cater to diverse applications.

At EPSI, our custom silicone mask process commences by gathering all relevant data from the client, including drawings, samples, and any other pertinent information.

Through a comprehensive consultation process, we discuss and determine the most suitable masking method to utilize. Our ultimate goal is to produce a final product that aligns with the client's precise requirements and specifications.

We believe that our proficient workforce, coupled with our extensive experience, enables us to consistently deliver quality custom silicone masks to our esteemed customers.

Go Custom with EPSI and SAVE!

# A12



## Green Poly Tape

<b>Maximum Temperature</b>	<b>400°F</b>
<b>Tensile Strength</b>	<b>25 lbs/inch</b>
<b>Elongation</b>	<b>70 %</b>
<b>Peel Adhesion</b>	<b>23 oz/inch</b>

» Total Thickness	3.2 mils
» Adhesive Thickness	1.2 mils
» Carrier Thickness	2.0 mils
» Adhesive Type	Silicone
» Carrier Type	Polyester
» Color	Green

400°F intermittent rating. Contact an EPSI representative for recommendations on tapes for continuous or extended use.  
Many factors can affect the use and performance of a product in a particular application.  
This product should be tested to determine the suitability for its intended use.

# A12

Part number	Length (yds)	Standard Width (in)	Width (in)	Length (m)	Width (mm)	Case Qty
A12-00032	72	1/8 in	0.125	66	3.2	
A12-00048	72	3/16 in	0.188	66	4.8	
A12-00064	72	1/4 in	0.250	66	6.4	128
A12-00070	72	2/7	.275	66	7	
A12-00079	72	5/16 in	0.313	66	8.0	96
A12-00095	72	3/8 in	0.375	66	9.5	84
A12-00102	72	2/5	.402	66	10.2	
A12-00111	72	7/16 in	0.438	66	11.1	
A12-00120	72	42/89	.472	66	12.0	
A12-00127	72	1/2 in	0.500	66	12.7	64
A12-00143	72	9/16 in	0.563	66	14.3	
A12-00159	72	5/8 in	0.625	66	15.9	48
A12-00178	72	2/3	.700	66	17.8	
A12-00190	72	3/4 in	0.750	66	19.0	
A12-00222	72	7/8 in	0.875	66	22.2	
A12-00254	72	1 in	1.000	66	25.4	32
A12-00286	72	1 1/8 in	1.125	66	28.6	
A12-00318	72	1 1/4 in	1.250	66	31.8	24
A12-00381	72	1 1/2 in	1.500	66	38.1	20
A12-00413	72	1 5/8 in	1.625	66	41.3	
A12-00445	72	1 3/4 in	1.750	66	44.5	16
A12-00508	72	2 in	2.000	66	50.8	16
A12-00572	72	2 1/4 in	2.250	66	57.2	12
A12-00635	72	2 1/2 in	2.500	66	63.5	12
A12-00699	72	2 3/4 in	2.750	66	69.9	8
A12-00762	72	3 in	3.000	66	76.2	12
A12-00794	72	3 1/4 in	3.125	66	79.4	
A12-00889	72	3 1/2 in	3.500	66	88.9	8
A12-01016	72	4 in	4.000	66	101.6	8
A12-01270	72	5 in	5.000	66	127.0	4
A12-01524	72	6 in	6.000	66	152.4	8
A12-01715	72	6 3/4	6.750	66	171.5	
A12-01778	72	7 in	7.000	66	177.8	4
A12-02032	72	8 in	8.000	66	203.2	4
A12-02540	72	10 in	10.000	66	254.0	
A12-03048	72	12 in	12.000	66	304.8	

Current pricing, case quantities and additional sizes available at [www.epsi.com](http://www.epsi.com)

Not all sizes are available in all warehouse locations - please check with your local sales rep for lead time and availability



# AD12

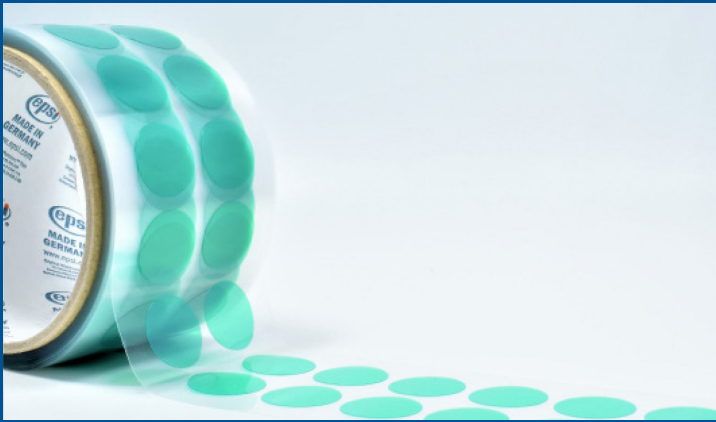

## Green Poly Tape Discs with slit back liner

Maximum Temperature	400°F
Tensile Strength	50 lbs/inch
Elongation	110 %
Peel Adhesion	35 oz/inch

» Total Thickness	3.2 mils
» Adhesive Thickness	1.2 mils
» Carrier Thickness	2.0 mils
» Adhesive Type	Silicone
» Carrier Type	Polyester
» Color	Green

Part number	Diameter (in)	Standard Diameter (in)	Diameter (mm)	Discs per Roll
AD12-0032-S	0.125	1/8 in	3.2	2000
AD12-0048-S	0.188	3/16 in	4.8	2000
AD12-0064-S	0.250	1/4 in	6.4	2000
AD12-0079-S	0.313	5/16 in	7.9	2000
AD12-0095-S	0.375	3/8 in	9.5	2000
AD12-0100-S	0.394	----	10.0	2000
AD12-0111-S	0.438	7/16 in	11.1	2000
AD12-0127-S	0.500	1/2 in	12.7	2000
AD12-0127 MEGA-S	0.500	1/2 in	12.7	10000

400°F intermittent rating. Contact an EPSI representative for recommendations on tapes for continuous or extended use. Many factors can affect the use and performance of a product in a particular application. This product should be tested to determine the suitability for its intended use.

# AD12

Part number	Diameter (in)	Standard Diameter (in)	Diameter (mm)	Discs Per Roll
AD12-0143-S	0.563	9/16 in	14.3	2000
AD12-0159-S	0.625	5/8 in	15.9	2000
AD12-0174-S	0.685	11/16 in	17.4	1000
AD12-0190-S	0.750	3/4 in	19.0	1000
AD12-0190 MEGA-S	0.750	3/4 in	19.0	5000
AD12-0222-S	0.875	7/8 in	22.2	1000
AD12-0237-S	0.937	15/16 in	23.7	500
AD12-0254-S	1.000	1 in	25.4	500
AD12-0254 MEGA-S	1.000	1 in	25.4	2500
AD12-0286-S	1.125	1 1/8 in	28.6	500
AD12-0302-S	1.187	1 3/16 in	30.2	500
AD12-0318-S	1.250	1 1/4 in	31.8	500
AD12-0349-S	1.375	1 3/8 in	34.9	500
AD12-0365-S	1.438	1 7/16 in	36.5	500
AD12-0381-S	1.500	1 1/2 in	38.1	500
AD12-0413-S	1.625	1 5/8 in	41.3	500
AD12-0445-S	1.750	1 3/4 in	44.5	500
AD12-0476-S	1.875	1 7/8 in	47.6	500
AD12-0508-S	2.000	2 in	50.8	250
AD12-0572-S	2.250	2 1/4 in	57.2	250
AD12-0572 MEGA-S	2.250	2 1/4 in	57.2	1250
AD12-0635-S	2.500	2 1/2 in	63.5	250
AD12-0635 MEGA-S	2.500	2 1/2 in	63.5	1250
AD12-0699-S	2.750	2 3/4 in	69.9	250
AD12-0762-S	3.000	3 in	76.2	250
AD12-0825-S	3.250	3 1/4 in	82.5	100
AD12-0889-S	3.500	3 1/2 in	88.9	100
AD12-0952-S	3.750	3 3/4 in	95.2	100
AD12-1016-S	4.000	4 in	101.6	100
AD12-1079-S	4.250	4 1/4 in	107.9	100
AD12-1143-S	4.500	4 1/2 in	114.3	100
AD12-1270-S	5.000	5 in	127.0	100
AD12-1397-S	5.500	5 1/2 in	139.7	100
AD12-1524-S	6.000	6 in	152.4	100
AD12-1588-S	6.250	6 1/4 in	158.8	100

Current pricing and additional sizes available at [www.epsi.com](http://www.epsi.com)

Not all sizes are available in all warehouse locations - please check with your local sales rep for lead time and availability



# AH12



## Green Poly Tape Donuts

Maximum Temperature	400°F
Tensile Strength	50 lbs/inch
Elongation	110 %
Peel Adhesion	35 oz/inch

» Total Thickness	3.2 mils
» Adhesive Thickness	1.2 mils
» Carrier Thickness	2.0 mils
» Adhesive Type	Silicone
» Carrier Type	Polyester
» Color	Green

Part number	ID (in)	OD (in)	ID (mm)	OD (mm)	Discs Per Roll
AH12-0095X0048	0.189	0.375	4.8	9.5	2000
AH12-0127X0064	0.250	0.500	6.4	12.7	2000
AH12-0159X0064	0.250	0.625	6.4	15.9	2000
AH12-0159X0095	0.375	0.625	9.5	15.9	2000
AH12-0190X0064	0.250	0.750	6.4	19.0	1000
AH12-0254X0048	0.189	1.000	4.8	25.4	500
AH12-0254X0064	0.250	1.000	6.4	25.4	500
AH12-0381X0095	0.375	1.500	9.5	25.4	500
AH12-0381X0254	1.000	1.500	25.4	25.4	500

Current pricing and additional sizes available at [www.epsi.com](http://www.epsi.com)

Not all sizes are available in all warehouse locations - please check with your local sales rep for lead time and availability

400°F intermittent rating. Contact an EPSI representative for recommendations on tapes for continuous or extended use.

Many factors can affect the use and performance of a product in a particular application.

This product should be tested to determine the suitability for its intended use.



# AW12

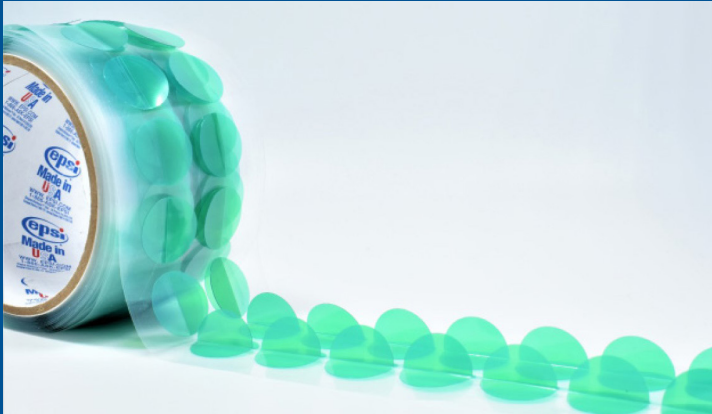

## Green Poly Wishbone Discs

<b>Maximum Temperature</b>	<b>400°F</b>
<b>Tensile Strength</b>	<b>50 lbs/inch</b>
<b>Elongation</b>	<b>110 %</b>
<b>Peel Adhesion</b>	<b>35 oz/inch</b>

» Total Thickness	3.2 mils
» Adhesive Thickness	1.2 mils
» Carrier Thickness	2.0 mils
» Adhesive Type	Silicone
» Carrier Type	Polyester
» Color	Green

400°F intermittent rating. Contact an EPSI representative for recommendations on tapes for continuous or extended use.  
Many factors can affect the use and performance of a product in a particular application.  
This product should be tested to determine the suitability for its intended use.

# AW12

Part number	Diameter (in)	Standard Diameter (in)	Diameter (mm)	Discs Per Roll
AW12-0095	0.375	3/8 in	9.5	500
AW12-0100	0.394	----	10.0	500
AW12-0111	0.438	7/16 in	11.1	500
AW12-0127	0.500	1/2 in	12.7	500
AW12-0143	0.563	9/16 in	14.3	500
AW12-0151	0.594	19/32 in	15.1	500
AW12-0159	0.625	5/8 in	15.9	500
AW12-0160	0.630	----	16.0	500
AW12-0174	0.685	11/16 in	17.4	500
AW12-0190	0.750	3/4 in	19.0	500
AW12-0200	0.787	----	20.0	500
AW12-0206	0.812	13/16 in	20.6	500
AW12-0214	0.843	27/32 in	21.4	500
AW12-0222	0.875	7/8 in	22.2	500
AW12-0254	1.000	1 in	25.4	500
AW12-0270	1.063	1 1/16 in	27.0	500
AW12-0286	1.125	1 1/8 in	28.6	500
AW12-0318	1.250	1 1/4 in	31.8	500
AW12-0349	1.375	1 3/8 in	34.9	500
AW12-0381	1.500	1 1/2 in	38.1	500
AW12-0413	1.625	1 5/8 in	41.3	250
AW12-0445	1.750	1 3/4 in	44.5	250
AW12-0476	1.875	1 7/8 in	47.6	250
AW12-0508	2.000	2 in	50.8	250
AW12-0572	2.250	2 1/4 in	57.2	100
AW12-0603	2.375	2 3/8 in	60.3	100
AW12-0635	2.500	2 1/2 in	63.5	100
AW12-0699	2.750	2 3/4 in	69.9	100
AW12-0762	3.000	3 in	76.2	100
AW12-1016	4.000	4 in	101.6	100

Current pricing and additional sizes available at [www.epsi.com](http://www.epsi.com)

Not all sizes are available in all warehouse locations - please check with your local sales rep for lead time and availability

400°F intermittent rating. Contact an EPSI representative for recommendations on tapes for continuous or extended use.  
 Many factors can affect the use and performance of a product in a particular application.  
 This product should be tested to determine the suitability for its intended use.





# B12



## Blue Poly Tape

<b>Maximum Temperature</b>	<b>392°F</b>
<b>Tensile Strength</b>	<b>31.5 lbs/inch</b>
<b>Elongation</b>	<b>50 %</b>
<b>Peel Adhesion</b>	<b>20 oz/inch</b>

» Total Thickness	3.0 mils
» Adhesive Thickness	2.0 mils
» Carrier Thickness	1.0 mils
» Adhesive Type	Silicone
» Carrier Type	Polyester
» Color	Blue

Part number	Length (yds)	Standard Width (in)	Width (in)	Length (m)	Width (mm)
B12-00032	72	1/8 in	0.125	66	3.2
B12-00064	72	1/4 in	0.250	66	6.4
B12-00127	72	1/2 in	0.500	66	12.7
B12-00190	72	3/4 in	0.750	66	19.0
B12-00254	72	1 in	1.000	66	25.4
B12-00381	72	1 1/2 in	1.500	66	38.1
B12-00508	72	2 in	2.000	66	50.8
B12-00635	72	2 1/2 in	2.500	66	63.5
B12-00762	72	3 in	3.000	66	76.2
B12-01016	72	4 in	4.000	66	101.6

Current pricing and additional sizes available at [www.epsi.com](http://www.epsi.com)

Not all sizes are available in all warehouse locations - please check with your local sales rep for lead time and availability

392°F intermittent rating. Contact an EPSI representative for recommendations on tapes for continuous or extended use.

Many factors can affect the use and performance of a product in a particular application.

This product should be tested to determine the suitability for its intended use.

# IDT9190



## Blue Poly Tape

<b>Maximum Temperature</b>	<b>350°F</b>
<b>Tensile Strength</b>	<b>22 lbs/inch</b>
<b>Elongation</b>	<b>80 %</b>
<b>Peel Adhesion</b>	<b>25 oz/inch</b>

- » Total Thickness 3.0 mils
- » Adhesive Thickness 2.0 mils
- » Carrier Thickness 1.0 mils
- » Adhesive Type Silicone
- » Carrier Type Polyester
- » Color Light Blue

Part number	Length (yds)	Standard Width (in)	Width (in)	Length (m)	Width (mm)
IDT9190-00032	72	1/8	0.125	66	3.2
IDT9190-00064	72	1/4 in	0.250	66	6.4
IDT9190-00127	72	1/2 in	0.500	66	12.7
IDT9190-00190	72	3/4	0.750	66	19.0
IDT9190-00254	72	1 in	1.000	66	25.4
IDT9190-00381	72	1 1/2 in	1.500	66	38.1
IDT9190-00508	72	2 in	2.000	66	50.8
IDT9190-00762	72	3 in	3.000	66	76.2
IDT9190-01016	72	4 in	4.000	66	101.6
IDT9190-01524	72	6 in	6.000	66	152.4

Current pricing and additional sizes available at [www.epsi.com](http://www.epsi.com)

Not all sizes are available in all warehouse locations - please check with your local sales rep for lead time and availability

350°F intermittent rating. Contact an EPSI representative for recommendations on tapes for continuous or extended use.

Many factors can affect the use and performance of a product in a particular application.

This product should be tested to determine the suitability for its intended use.



# D12



## Red Poly Tape

<b>Maximum Temperature</b>	<b>400°F</b>
<b>Tensile Strength</b>	<b>30 lbs/inch</b>
<b>Elongation</b>	<b>120 %</b>
<b>Peel Adhesion</b>	<b>35 oz/inch</b>

» Total Thickness	4.0 mils
» Adhesive Thickness	3.0 mils
» Carrier Thickness	1.0 mils
» Adhesive Type	Silicone
» Carrier Type	Polyester
» Color	Red

Part number	Length (yds)	Standard Width (in)	Width (in)	Length (m)	Width (mm)
D12-00064	72	1/4	0.250	66	6.4
D12-00127	72	1/2 in	0.500	66	12.7
D12-00190	72	3/4 in	0.750	66	19.0
D12-00254	72	1 in	1.000	66	25.4
D12-00381	72	1 1/2 in	1.500	66	38.1
D12-00508	72	2 in	2.000	66	50.8

Current pricing and additional sizes available at [www.epsi.com](http://www.epsi.com)

Not all sizes are available in all warehouse locations - please check with your local sales rep for lead time and availability

350°F intermittent rating. Contact an EPSI representative for recommendations on tapes for continuous or extended use.

Many factors can affect the use and performance of a product in a particular application.

This product should be tested to determine the suitability for its intended use.



# 012



## Ultra Orange Poly Tape

<b>Maximum Temperature</b>	<b>400°F</b>
<b>Tensile Strength</b>	<b>25 lbs/inch</b>
<b>Elongation</b>	<b>70 %</b>
<b>Peel Adhesion</b>	<b>23 oz/inch</b>

» Total Thickness	3.2 mils
» Adhesive Thickness	1.2 mils
» Carrier Thickness	2.0 mils
» Adhesive Type	Silicone
» Carrier Type	Polyester
» Color	Orange

430°F intermittent rating. Contact an EPSI representative for recommendations on tapes for continuous or extended use. Many factors can affect the use and performance of a product in a particular application. This product should be tested to determine the suitability for its intended use.

# 012

Part number	Length (yds)	Standard Width (in)	Width (in)	Length (m)	Width (mm)	Case Qty
O12-00032	72	1/8 in	0.125	66	3.2	
O12-00048	72	3/16 in	0.188	66	4.8	
O12-00064	72	1/4 in	0.250	66	6.4	
O12-00079	72	5/16 in	0.313	66	7.9	
O12-00095	72	3/8 in	0.375	66	9.5	
O12-00111	72	7/16 in	0.438	66	11.1	
O12-00127	72	1/2 in	0.500	66	12.7	64
O12-00143	72	9/16 in	0.563	66	14.3	
O12-00159	72	5/8 in	0.625	66	15.9	
O12-00190	72	3/4 in	0.750	66	19.0	40
O12-00222	72	7/8 in	0.875	66	22.2	
O12-00254	72	1 in	1.000	66	25.4	32
O12-00286	72	1 1/8 in	1.125	66	28.6	
O12-00318	72	1 1/4 in	1.250	66	31.8	24
O12-00349	72	1 3/8 in	1.375	66	34.9	
O12-00381	72	1 1/2 in	1.500	66	38.1	20
O12-00413	72	1 5/8 in	1.625	66	41.3	
O12-00445	72	1 3/4 in	1.750	66	44.5	
O12-00508	72	2 in	2.000	66	50.8	16
O12-00572	72	2 1/4 in	2.250	66	57.2	12
O12-00635	72	2 1/2 in	2.500	66	63.5	
O12-00699	72	2 3/4 in	2.750	66	69.9	
O12-00762	72	3 in	3.000	66	76.2	12
O12-00889	72	3 1/2 in	3.500	66	88.9	
O12-01016	72	4 in	4.000	66	101.6	
O12-01270	72	5 in	5.000	66	127.0	
O12-01524	72	6 in	6.000	66	152.4	
O12-01778	72	7 in	7.000	66	177.8	
O12-02032	72	8 in	8.000	66	203.2	
O12-02540	72	10 in	10.000	66	254.0	
O12-03048	72	12 in	12.000	66	304.8	

Current pricing, case quantities and additional sizes available at [www.epsi.com](http://www.epsi.com)

Not all sizes are available in all warehouse locations - please check with your local sales rep for lead time and availability



# SPVC



## Sandblasting Tape

<b>Maximum Temperature</b>	<b>176°F</b>
<b>Tensile Strength</b>	<b>32 lbs/inch</b>
<b>Elongation</b>	<b>360 %</b>
<b>Peel Adhesion</b>	<b>11 oz/inch</b>

- » Total Thickness 20 mils
- » Adhesive Type Rubber / Resin Adhesive
- » Carrier Type Black Matte soft PVC
- » Color Black

Part number	Color	WIDTH (in)	WIDTH (mm)	LENGTH
SPVC-00254	black	1.0 in	25.4	100ft
SPVC-00508	black	2.0 in	50.8	100ft
SPVC-00762	black	3.0 in	76.2	100ft
SPVC-01016	black	4.0 in	101.6	100ft
SPVC-01524	black	6.0 in	152.4	100ft

Current pricing and additional sizes available at [www.epsi.com](http://www.epsi.com)

Not all sizes are available in all warehouse locations - please check with your local sales rep for lead time and availability

# F12



## Fiberglass (Glass Cloth) Tape

<b>Maximum Temperature</b>	<b>500°F</b>
<b>Tensile Strength</b>	<b>170 lbs/inch</b>
<b>Elongation</b>	<b>8 %</b>
<b>Peel Adhesion</b>	<b>40 oz/inch</b>
<b>Dielectric Strength</b>	<b>3000 volts</b>
<b>Insulation Resistance</b>	<b>1500 meg ohms</b>

» Total Thickness	7.0 mils
» Adhesive Thickness	2.0 mils
» Carrier Thickness	5.0 mils
» Adhesive Type	Silicone
» Carrier Type	Glass Cloth
» Color	White

Part number	Length (yds)	Standard Width (in)	Width (in)	Length (m)	Width (mm)
F12-00095	36	3/8 in	0.375	33	9.5
F12-00127	36	1/2 in	0.500	33	12.7
F12-00190	36	3/4 in	0.750	33	19.1
F12-00254	36	1 in	1.000	33	25.4
F12-00318	36	1 1/4 in	1.250	33	31.8
F12-00381	36	1 1/2 in	1.500	33	38.1
F12-00508	36	2 in	2.000	33	50.8
F12-00635	36	2 1/2 in	2.500	33	63.5
F12-00762	36	3 in	3.000	33	76.2
F12-01016	36	4 in	4.000	33	101.6
F12-01270	36	5 in	5.000	33	127.0

Current pricing and additional sizes available at [www.epsi.com](http://www.epsi.com)

Not all sizes are available in all warehouse locations - please check with your local sales rep for lead time and availability

500°F intermittent rating. Contact an EPSI representative for recommendations on tapes for continuous or extended use.

Many factors can affect the use and performance of a product in a particular application.

This product should be tested to determine the suitability for its intended use.



# FD12



## Fiberglass (Glass Cloth) Dots

<b>Maximum Temperature</b>	<b>500°F</b>
<b>Tensile Strength</b>	<b>170 lbs/inch</b>
<b>Elongation</b>	<b>8 %</b>
<b>Peel Adhesion</b>	<b>40 oz/inch</b>
<b>Dielectric Strength</b>	<b>3000 volts</b>
<b>Insulation Resistance</b>	<b>1500 meg ohms</b>

- » Total Thickness 7.0 mils
- » Adhesive Thickness 2.0 mils
- » Carrier Thickness 5.0 mils
- » Adhesive Type Silicone
- » Carrier Type Glass Cloth
- » Color White

Part number	Length (yds)	Standard Diameter (in)	Diameter (in)	Length (m)	Diameter (mm)	Discs Per Roll
FD12-0127	36	1/2 in	0.500	33	12.7	2000
FD12-0190	36	3/4 in	0.750	33	19.0	1000
FD12-0254	36	1 in	1.000	33	25.4	500
FD12-0381	36	1 1/2 in	1.500	33	38.1	500
FD12-0508	36	2 in	2.000	33	50.8	100

Current pricing and additional sizes available at [www.epsi.com](http://www.epsi.com)

Not all sizes are available in all warehouse locations - please check with your local sales rep for lead time and availability

500°F intermittent rating. Contact an EPSI representative for recommendations on tapes for continuous or extended use. Many factors can affect the use and performance of a product in a particular application. This product should be tested to determine the suitability for its intended use.





# K22



## 2 mil Polyimide Tape

<b>Maximum Temperature</b>	<b>500°F</b>
<b>Tensile Strength</b>	<b>30 lbs/inch</b>
<b>Elongation</b>	<b>45 %</b>
<b>Peel Adhesion</b>	<b>20 oz/inch</b>
<b>Dielectric Strength</b>	<b>12000 volts</b>

» Total Thickness	3.15 mils
» Adhesive Thickness	1.18mils
» Carrier Thickness	1.97 mils
» Adhesive Type	Silicone
» Carrier Type	Polyimide
» Color	Amber

Part number	Length (yds)	Standard Width (in)	Width (in)	Length (m)	Width (mm)
K22-00032	36	1/8 in	0.013	33	3.2
K22-00064	36	1/4 in	0.250	33	6.4
K22-00095	36	3/8 in	0.375	33	9.5
K22-00111	36	7/16 in	0.437	33	11.1
K22-00127	36	1/2 in	0.500	33	12.7
K22-00159	36	5/8 in	0.625	33	15.9
K22-00190	36	3/4 in	0.750	33	19.1
K22-00254	36	1 in	1.000	33	25.4
K22-00286	36	1 1/8 in	1.125	33	28.6
K22-00381	36	1 1/2 in	1.500	33	38.1
K22-00508	36	2 in	2.000	33	50.8
K22-00762	36	3 in	3.000	33	76.2
K22-01016	36	4 in	4.000	33	101.6

Current pricing and additional sizes available at [www.epsi.com](http://www.epsi.com)

Not all sizes are available in all warehouse locations - please check with your local sales rep for lead time and availability

500°F intermittent rating. Contact an EPSI representative for recommendations on tapes for continuous or extended use.

Many factors can affect the use and performance of a product in a particular application.

This product should be tested to determine the suitability for its intended use.



# KD22



## 2 mil Polyimide Discs

<b>Maximum Temperature</b>	<b>600°F</b>
<b>Tensile Strength</b>	<b>55 lbs/inch</b>
<b>Elongation</b>	<b>60 %</b>
<b>Peel Adhesion</b>	<b>19 oz/inch</b>
<b>Dielectric Strength</b>	<b>12000 volts</b>

- » Total Thickness 3.2 mils
- » Adhesive Thickness 1.2 mils
- » Carrier Thickness 2.0 mils
- » Adhesive Type Silicone
- » Carrier Type Polyimide
- » Color Amber

Part number	Diameter (in)	Standard Diameter (in)	Diameter (mm)	Discs Per Roll
KD22-0064	0.250	1/4 in	6.4	2000
KD22-0087	0.343	11/32 in	8.7	2000
KD22-0095	0.375	3/8 in	9.5	2000
KD22-0127	0.500	1/2 in	12.7	2000
KD22-0190	0.750	3/4 in	19.0	1000
KD22-0254	1.000	1 in	25.4	500
KD22-0381	1.500	1 1/2 in	38.1	500
KD22-0508	2.000	2 in	50.8	100

Current pricing and additional sizes available at [www.epsi.com](http://www.epsi.com)

Not all sizes are available in all warehouse locations - please check with your local sales rep for lead time and availability

600°F intermittent rating. Contact an EPSI representative for recommendations on tapes for continuous or extended use. Many factors can affect the use and performance of a product in a particular application. This product should be tested to determine the suitability for its intended use.



# K12



## 1 mil Polyimide Tape

<b>Maximum Temperature</b>	<b>500°F</b>
<b>Tensile Strength</b>	<b>30 lbs/inch</b>
<b>Elongation</b>	<b>35 %</b>
<b>Peel Adhesion</b>	<b>18 oz/inch</b>
<b>Dielectric Strength</b>	<b>6800 volts</b>

» Total Thickness	2.2 mils
» Adhesive Thickness	1.2 mils
» Carrier Thickness	1.0 mils
» Adhesive Type	Silicone
» Carrier Type	Polyimide
» Color	Amber

Part number	Length (yds)	Standard Width (in)	Width (in)	Length (m)	Width (mm)
K12-00032	36	1/8 in	0.013	33	3.2
K12-00064	36	1/4 in	0.250	33	6.4
K12-00095	36	3/8 in	0.375	33	9.5
K12-00127	36	1/2 in	0.500	33	12.7
K12-00159	36	5/8 in	0.625	33	15.9
K12-00190	36	3/4 in	0.750	33	19.1
K12-00254	36	1 in	1.000	33	25.4
K12-00286	36	1 1/8 in	1.125	33	28.6
K12-00318	36	1 1/4 in	1.250	33	31.8
K12-00381	36	1 1/2 in	1.500	33	38.1
K12-00508	36	2 in	2.000	33	50.8
K12-00762	36	3 in	3.000	33	76.2
K12-01016	36	4 in	4.000	33	101.6
K12-01524	36	6 in	6.000	33	152.4

Current pricing and additional sizes available at [www.epsi.com](http://www.epsi.com)  
 Not all sizes are available in all warehouse locations - please check with your local sales rep for lead time and availability

500°F intermittent rating. Contact an EPSI representative for recommendations on tapes for continuous or extended use.  
 Many factors can affect the use and performance of a product in a particular application.  
 This product should be tested to determine the suitability for its intended use.

# 3M2380



## Crepe Masking Tape

Maximum Temperature	325°F
Tensile Strength	27 lbs/inch
Elongation	10 %
Peel Adhesion	43 oz/inch

- » Total Thickness 7.5 mils
- » Adhesive Type Natural/synthetic rubber blend
- » Carrier Type A smooth crepe paper treated with a heat and solvent resistant saturant
- » Color Tan

Part number	Length (yds)	Standard Width (in)	Width (in)	Length (m)	Width (mm)
3M2380-00127	60	1/2 in	0.500	55	12.7
3M2380-00190	60	3/4 in	0.750	55	19.1
3M2380-00254	60	1 in	1.000	55	25.4
3M2380-00381	60	1 1/2 in	1.500	55	38.1
3M2380-00508	60	2 in	2.000	55	50.8
3M2380-00762	60	3 in	3.000	55	76.2
3M2380-01016	60	4 in	4.000	55	101.6
3M2380-01524	60	6 in	6.000	55	152.4

Current pricing and additional sizes available at [www.epsi.com](http://www.epsi.com)

Not all sizes are available in all warehouse locations - please check with your local sales rep for lead time and availability

325°F intermittent rating. Contact an EPSI representative for recommendations on tapes for continuous or extended use. Many factors can affect the use and performance of a product in a particular application. This product should be tested to determine the suitability for its intended use.



# C21



## Hi-Temp Crepe Masking Tape

<b>Maximum Temperature</b>	<b>325°F</b>
<b>Tensile Strength</b>	<b>18 lbs/inch</b>
<b>Elongation</b>	<b>10 %</b>
<b>Peel Adhesion</b>	<b>28 oz/inch</b>

- » Total Thickness 7.3 mils
- » Adhesive Thickness 1.3 mils
- » Carrier Thickness 6.0 mils
- » Adhesive Type Rubber
- » Carrier Type Smooth Crepe Paper
- » Color Tan; Kraft

Part number	Length (yds)	Standard Width (in)	Width (in)	Length (m)	Width (mm)	Case Qty
C21-00064	60	1/4 in	0.250	55	6.4	
C21-00095	60	3/8 in	0.375	55	9.5	
C21-00127	60	1/2 in	0.500	55	12.7	72
C21-00190	60	3/4 in	0.750	55	19.1	
C21-00254	60	1 in	1.000	55	25.4	36
C21-00318	60	1 1/4 in	1.250	55	31.8	
C21-00381	60	1 1/2 in	1.500	55	38.1	24
C21-00508	60	2 in	2.000	55	50.8	24
C21-00635	60	2 1/2 in	2.500	55	63.5	
C21-00762	60	3 in	3.000	55	76.2	12
C21-01016	60	4 in	4.000	55	101.6	
C21-01270	60	5 in	5.000	55	127.0	
C21-01524	60	6 in	6.000	55	152.4	

Current pricing and additional sizes available at [www.epsi.com](http://www.epsi.com)

Not all sizes are available in all warehouse locations - please check with your local sales rep for lead time and availability

325°F intermittent rating. Contact an EPSI representative for recommendations on tapes for continuous or extended use. Many factors can affect the use and performance of a product in a particular application. This product should be tested to determine the suitability for its intended use.

# CD21

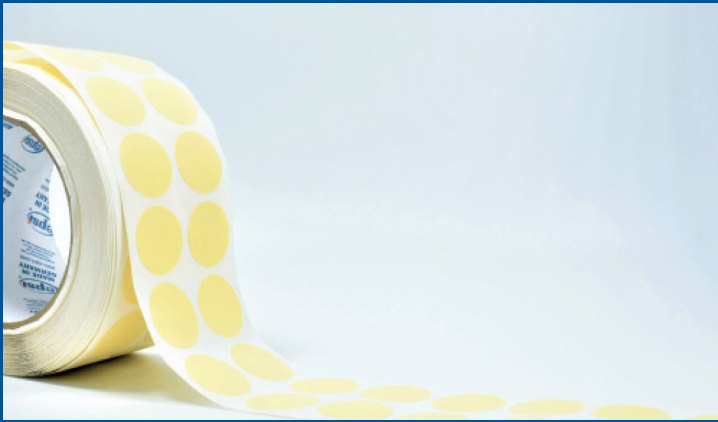

## Hi-Temp Crepe Masking Discs

<b>Maximum Temperature</b>	<b>325°F</b>
<b>Tensile Strength</b>	<b>26 lbs/inch</b>
<b>Elongation</b>	<b>10 %</b>
<b>Peel Adhesion</b>	<b>28 oz/inch</b>

- » Total Thickness 7.3 mils
- » Adhesive Type Rubber / Resin Adhesive
- » Carrier Type Fine Structured Crepe Paper
- » Color Tan; Kraft

325°F intermittent rating. Contact an EPSI representative for recommendations on tapes for continuous or extended use. Many factors can affect the use and performance of a product in a particular application. This product should be tested to determine the suitability for its intended use.

# CD21

Part number	Diameter (in)	Standard Diameter (in)	Diameter (mm)	Discs Per Roll
CD21-0032	0.125	1/8 in	3.2	5000
CD21-0048	0.188	3/16 in	4.8	5000
CD21-0056	0.220	7/32 in	5.6	5000
CD21-0064	0.250	1/4 in	6.4	5000
CD21-0079	0.313	5/16 in	7.9	5000
CD21-0095	0.375	3/8 in	9.5	5000
CD21-0103	0.406	13/32 in	10.3	5000
CD21-0111	0.438	7/16 in	11.1	5000
CD21-0127	0.500	1/2 in	12.7	5000
CD21-0143	0.563	9/16 in	14.3	5000
CD21-0159	0.625	5/8 in	15.9	5000
CD21-0190	0.750	3/4 in	19.0	4000
CD21-0222	0.875	7/8 in	22.2	2000
CD21-0254	1.000	1 in	25.4	2000
CD21-0286	1.125	1 1/8 in	28.6	2000
CD21-0318	1.250	1 1/4 in	31.8	2000
CD21-0349	1.375	1 3/8 in	34.9	2000
CD21-0381	1.500	1 1/2 in	38.1	2000
CD21-0445	1.750	1 3/4 in	44.5	1000
CD21-0508	2.000	2 in	50.8	500
CD21-0572	2.250	2 1/4 in	57.2	500
CD21-0635	2.500	2 1/2 in	63.5	500
CD21-0699	2.750	2 3/4 in	69.9	500
CD21-0762	3.000	3 in	76.2	500
CD21-0889	3.500	3 1/2 in	88.9	500
CD21-1016	4.000	4 in	101.6	250
CD21-1079	4.250	4 1/4 in	107.9	250
CD21-1143	4.500	4 1/2 in	114.3	250
CD21-1270	5.000	5 in	127.0	250
CD21-1524	6.000	6 in	152.4	250
CD21-2032	8.000	8 in	203.2	100

Current pricing and additional sizes available at [www.epsi.com](http://www.epsi.com)

Not all sizes are available in all warehouse locations - please check with your local sales rep for lead time and availability



# IPG PG21



## General Purpose Crepe Tape

<b>Maximum Temperature</b>	<b>325°F</b>
<b>Tensile Strength</b>	<b>26 lbs/inch</b>
<b>Elongation</b>	<b>10 %</b>
<b>Peel Adhesion</b>	<b>28 oz/inch</b>

- » Total Thickness 7.3 mils
- » Adhesive Type Rubber / Resin Adhesive
- » Carrier Type Fine Structure Crepe Paper
- » Color Tan

Part number	Length (yds)	Standard Width (in)	Width (in)	Length (m)	Width (mm)	Case Qty
PG21-00120 (case)	60	1/2 in	0.472	55	12	72
PG21-00127	60	1/2 in	0.500	55	12.7	
PG21-00190	60	3/4 in	0.750	55	19.1	
PG21-00240 (case)	60	1 in	0.945	55	24	36
PG21-00254	60	1 in	1.000	55	25.4	
PG21-00360 (case)	60	1 3/7 in	1.417	55	36	24
PG21-00381	60	1 1/2 in	1.500	55	38.1	
PG21-00480 (case)	60	1 8/9 in	1.889	55	48	24
PG21-00508	60	2 in	2.000	55	50.8	
PG21-00720 (case)	60	2 5/6 in	2.835	55	72	16
PG21-00762	60	3 in	3.000	55	76.2	

Current pricing and additional sizes available at [www.epsi.com](http://www.epsi.com)

Not all sizes are available in all warehouse locations - please check with your local sales rep for lead time and availability

325°F intermittent rating. Contact an EPSI representative for recommendations on tapes for continuous or extended use.  
 Many factors can affect the use and performance of a product in a particular application.  
 This product should be tested to determine the suitability for its intended use.





# V10



## General Purpose Vinyl Tape

<b>Maximum Temperature</b>	<b>176°F</b>
<b>Tensile Strength</b>	<b>16 lbs/inch</b>
<b>Elongation</b>	<b>150 %</b>
<b>Peel Adhesion</b>	<b>22 oz/inch</b>

- » Total Thickness 5.1 mils
- » Adhesive Type Synthetic Rubber Resin
- » Carrier Type Matte surface, soft PVC
- » Color Purple

Part number	Length (yds)	Standard Width (in)	Width (in)	Length (m)	Width (mm)
V10-00127	36	1/2 in	0.500	33	12.7
V10-00190	36	3/4 in	0.750	33	19.1
V10-00254	36	1 in	1.000	33	25.4
V10-00381	36	1 1/2 in	1.500	33	38.1
V10-00508	36	2 in	2.000	33	50.8

Current pricing and additional sizes available at [www.epsi.com](http://www.epsi.com)

Not all sizes are available in all warehouse locations - please check with your local sales rep for lead time and availability

176°F intermittent rating. Contact an EPSI representative for recommendations on tapes for continuous or extended use. Many factors can affect the use and performance of a product in a particular application. This product should be tested to determine the suitability for its intended use.

# V12



## Electroplating Vinyl Tape

<b>Maximum Temperature</b>	<b>176°F</b>
<b>Tensile Strength</b>	<b>25 lbs/inch</b>
<b>Elongation</b>	<b>200 %</b>
<b>Peel Adhesion</b>	<b>30 oz/inch</b>

- » Total Thickness 6.5 mils
- » Adhesive Type Rubber Based
- » Carrier Type Soft PVC (non-rigid vinyl)
- » Color Yellow

Part number	Length (yds)	Standard Width (in)	Width (in)	Length (m)	Width (mm)
V12-00127	36	1/2 in	0.500	33	12.7
V12-00190	36	3/4 in	0.750	33	19.1
V12-00254	36	1 in	1.000	33	25.4
V12-00381	36	1 1/2 in	1.500	33	38.1
V12-00508	36	2 in	2.000	33	50.8

Current pricing and additional sizes available at [www.epsi.com](http://www.epsi.com)

Not all sizes are available in all warehouse locations - please check with your local sales rep for lead time and availability

176°F intermittent rating. Contact an EPSI representative for recommendations on tapes for continuous or extended use. Many factors can affect the use and performance of a product in a particular application. This product should be tested to determine the suitability for its intended use.



# V71



## Non-Adhesive Vinyl Tape

<b>Maximum Temperature</b>	<b>200°F</b>
<b>Tensile Strength</b>	<b>11.5 lbs/inch</b>
<b>Elongation</b>	<b>250 %</b>

- » Total Thickness 4.0 mils
- » Carrier Type Polyvinyl Chloride Film
- » Color Yellow

Part number	Length (ft)	Standard Width (in)	Width (in)	Length (m)	Width (mm)
V71-00190	250	3/4 in	0.750	76	19.0
V71-00254	250	1 in	1.000	76	25.4
V71-00381	250	1 1/2 in	1.500	76	38.1
V71-00508	250	2 in	2.000	76	50.8
V71-00762	250	3 in	3.000	76	76.2

Current pricing and additional sizes available at [www.epsi.com](http://www.epsi.com)

Not all sizes are available in all warehouse locations - please check with your local sales rep for lead time and availability

176°F intermittent rating. Contact an EPSI representative for recommendations on tapes for continuous or extended use. Many factors can affect the use and performance of a product in a particular application. This product should be tested to determine the suitability for its intended use.

# S10/S20/S30



## Silicone Self-Fusing Tape

<b>Temperature Range</b>	<b>Continuous: -65 to 500°F</b> <b>Intermittent: -85 to 600°F</b>
<b>Tensile Strength</b>	<b>700 PSI Minimum</b> <b>(ASTM D-412)</b>
<b>Elongation</b>	<b>300 %</b>
<b>Tear Resistance</b>	<b>85 PSI</b>
<b>Durometer (Shore A)</b>	<b>50 (Room Cured)</b>

» Dielectric Strength (VPM)	200 - 400
» Dielectric Constant (1 KHz)	2.95
» Dissipation Factor (1KHz)	<.0004
» Insulation Resistance (ohms/cm)	3 X 10 <sup>14</sup>
» Moisture Absorption	3% Max. by weight
» Government Specifications	Meets or Exceeds A-A-59163 (Supersedes mils I-46852C)

## S10 series

Part number	Color	Length (yds)	Standard Width (in)	Width (in)	Length (m)	Width (mm)
S10-00127-Y	grey	18	1/2 in	0.500	16	12.7
S10-00191-Y	grey	18	3/4 in	0.750	16	19.1
S10-00254-Y	grey	18	1 in	1.000	16	25.4

Flat

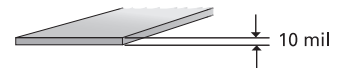

## S20 series

Part number	Color	Length (yds)	Standard Width (in)	Width (in)	Length (m)	Width (mm)
S20-00254-F	rusty	12	1 in	1.000	11	25.4
S20-00381-F	rusty	12	1 1/2 in	1.500	11	38.1
S20-00508-F	rusty	12	2 in	2.000	11	50.8

Triangle

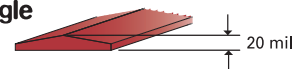

## S30 series

Part number	Color	Length (yds)	Standard Width (in)	Width (in)	Length (m)	Width (mm)
S30-00254-B	black	12	1 in	1.000	11	25.4
S30-00381-B	black	12	1 1/2 in	1.500	11	38.1
S30-00508-B	black	12	2 in	2.000	11	50.8

Triangle

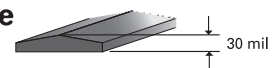

600°F intermittent rating. Contact an EPSI representative for recommendations on tapes for continuous or extended use. Many factors can affect the use and performance of a product in a particular application. This product should be tested to determine the suitability for its intended use.

# Custom Plotter

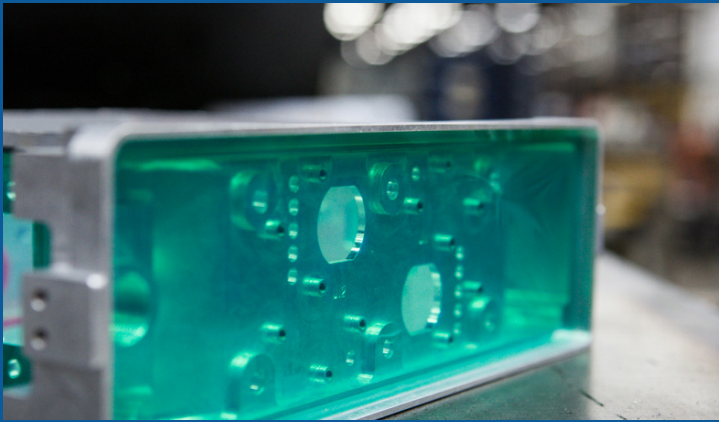

Are you spending too much on masking labor?  
Is your line speed suffering due to complicated masking?  
Do you want to reduce your 3P cost (per painted part)?  
If so, custom plotters from EPSI are for you!

The EPSI Guarantee means we provide you with the best solution for your masking needs. Frequently, it's guaranteed in-stock products like our A12 green tape or our patented Wish-bone discs. But, occasionally only a custom shape will do and only EPSI can provide these custom pieces as quick and affordable as standard masking products.

Plotter cutting is a highly customized and economic process for quickly developing custom solutions for complicated masks and irregular shapes. Additionally, EPSI can place whole sets of plotter cut masks onto a single roll, reducing masking time and labor costs.

Through a comprehensive consultation process, we discuss and determine the most suitable masking method to utilize. Our ultimate goal is to produce a final product that aligns with the client's precise requirements and specifications.

Ask your local Sales Representative today about our custom Crepe, Green Ploy Tape, Orange Poly Tape or Kapton Tape plotters today.

Go Custom with EPSI and SAVE!



## V-Hooks

- » V-hook geometry allows for extreme stability while loaded (compare to other hook geometries)
- » Provides superior grounding due to multiple grounding contact points

### Explanation of Hook Product Numbers:

(ie; HV 60060-2525)

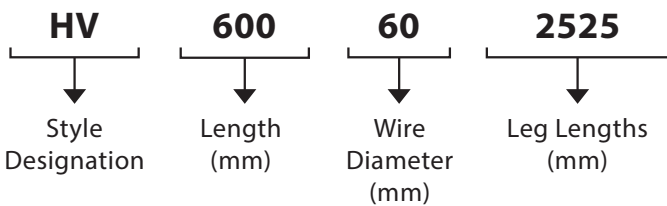

### HOOK LOADING COMPARISON (2X SAFETY FACTOR)

Round Wire			
0.062"	1.575 mm	DIAMETER HD SPRING WIRE	4 LBS
0.076"	1.930 mm	DIAMETER HD SPRING WIRE	7 LBS
0.120"	3.048 mm	DIAMETER HD SPRING WIRE	25 LBS
0.180"	4.572 mm	DIAMETER HD SPRING WIRE	75 LBS
0.250"	6.350 mm	DIAMETER CRS 1008 WIRE	60 LBS

HD=Hard Drawn CRS=Cold Rolled Steel

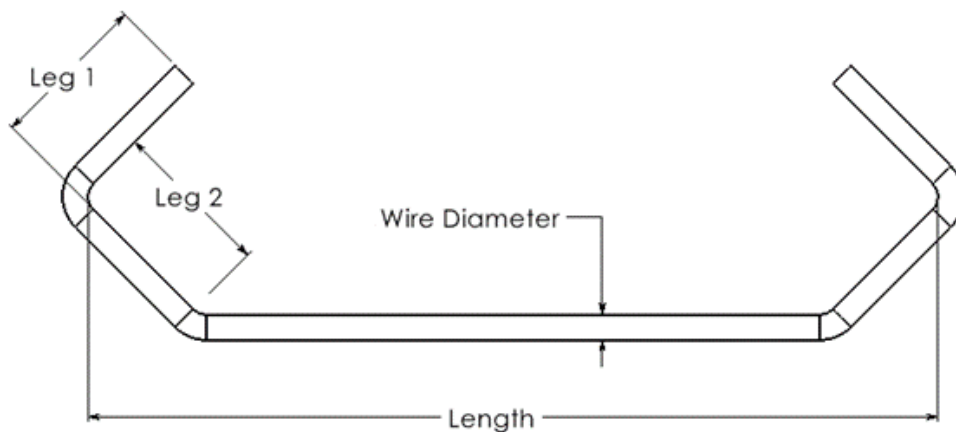

NOTE: The recommended safe load limits were compiled under static load conditions in a laboratory fully accredited by the American Association for Laboratory Accreditation, conforming to ISO Guide 25. Although all load limits incorporate a safety factor, many factors will affect the actual dynamic load capacity of a hook. Such factors include sudden change in line speed, vibration in the conveyor, or in the case of suspension from two hooks, a shift in the center of gravity caused by an incline or stretching along curves in the conveyor. This product should be tested to determine the suitability for its intended use.

\* Please call your EPSI representative for further details.

Part number	Leg 1 (in)	Leg 2 (in)	Length (in)	Wire Diameter (in)	Leg 1 (mm)	Leg 2 (mm)	Length (mm)	Wire Diameter (mm)	Box Qty
HV 07515-2121	0.810	0.810	3.000	0.060	21	21	75	1.5	2500
HV 07520-2121	0.810	0.810	3.000	0.080	21	21	75	2.0	2500
HV 10015-2121	0.810	0.810	4.000	0.060	21	21	100	1.5	2500
HV 10020-2121	0.810	0.810	4.000	0.080	21	21	100	2.0	2500
HV 10030-2121	0.810	0.810	4.000	0.120	21	21	100	3.0	1000
HV 10045-2121	0.810	0.810	4.000	0.180	21	21	100	4.5	500
HV 15015-2525	1.000	1.000	6.000	0.060	21	25	150	1.5	2500
HV 15020-2525	1.000	1.000	6.000	0.080	21	25	150	2.0	2500
HV 15030-2525	1.000	1.000	6.000	0.120	25	25	150	3.0	1000
HV 15045-2525	1.000	1.000	6.000	0.180	25	25	150	4.5	500
HV 15060-2525	1.000	1.000	6.000	0.250	25	25	150	6.0	250
HV 20020-2525	1.000	1.000	8.000	0.080	25	25	200	2.0	2500
HV 20030-2525	1.000	1.000	8.000	0.120	25	25	200	3.0	1000
HV 20045-2525	1.000	1.000	8.000	0.180	25	25	200	4.5	500
HV 20060-2525	1.000	1.000	8.000	0.250	25	25	200	6.0	500
HV 25020-2525	1.000	1.000	10.000	0.080	25	25	250	2.0	2500
HV 25030-2525	1.000	1.000	10.000	0.120	25	25	250	3.0	1000
HV 30020-2525	1.000	1.000	12.000	0.080	25	25	300	2.0	1000
HV 30030-2525	1.000	1.000	12.000	0.120	25	25	300	3.0	500
HV 30045-2525	1.000	1.000	12.000	0.180	25	25	300	4.5	250
HV 30060-2525	1.000	1.000	12.000	0.250	25	25	300	6.0	250
HV 37520-2525	1.000	1.000	15.000	0.080	25	25	375	2.0	1000
HV 37560-2525	1.000	1.000	15.000	0.250	25	25	375	6.0	250
HV 45020-2525	1.000	1.000	18.000	0.080	25	25	450	2.0	1000
HV 45030-2525	1.000	1.000	18.000	0.120	25	25	450	3.0	500
HV 45045-2525	1.000	1.000	18.000	0.180	25	25	450	4.5	250
HV 45060-2525	1.000	1.000	18.000	0.250	25	25	450	6.0	250
HV 60020-2525	1.000	1.000	24.000	0.080	25	25	600	2.0	1000
HV 60030-2525	1.000	1.000	24.000	0.120	25	25	600	3.0	500
HV 60045-2525	1.000	1.000	24.000	0.180	25	25	600	4.5	100
HV 60060-2525	1.000	1.000	24.000	0.250	25	25	600	6.0	100

Current pricing and additional sizes available at [www.epsi.com](http://www.epsi.com)

Not all sizes are available in all warehouse locations - please check with your local sales rep for lead time and availability

# HV90



## V-Hook, 90° bend

- » V-hook geometry allows for extreme stability while loaded (compare to other hook geometries)
- » 90° bend allows for specific hanging orientation

### Explanation of Hook Product Numbers: (ie; HV90 15045-2525)

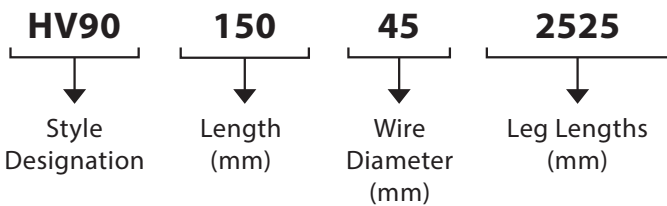

### HOOK LOADING COMPARISON (2X SAFETY FACTOR)

Round Wire			
0.062"	1.575 mm	DIAMETER HD SPRING WIRE	4 LBS
0.076"	1.930 mm	DIAMETER HD SPRING WIRE	7 LBS
0.120"	3.048 mm	DIAMETER HD SPRING WIRE	25 LBS
0.180"	4.572 mm	DIAMETER HD SPRING WIRE	75 LBS
0.250"	6.350 mm	DIAMETER CRS 1008 WIRE	60 LBS

HD=Hard Drawn CRS=Cold Rolled Steel

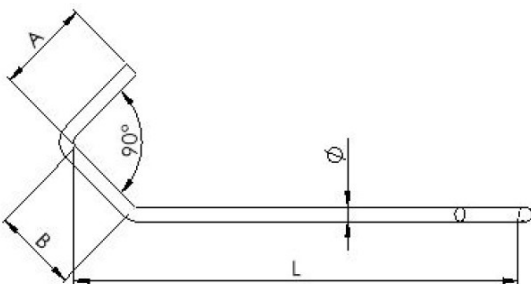

NOTE: The recommended safe load limits were compiled under static load conditions in a laboratory fully accredited by the American Association for Laboratory Accreditation, conforming to ISO Guide 25. Although all load limits incorporate a safety factor, many factors will affect the actual dynamic load capacity of a hook. Such factors include sudden change in line speed, vibration in the conveyor, or in the case of suspension from two hooks, a shift in the center of gravity caused by an incline or stretching along curves in the conveyor. This product should be tested to determine the suitability for its intended use.

\* Please call your EPSI representative for further details.



# HV90

Part number	A (in)	B (in)	Length (in)	Wire Diameter (in)	A (mm)	B (mm)	Length (mm)	Wire Diameter (mm)	Box Qty
HV90 07515-2121	0.810	0.810	3.000	0.060	21	21	75	1.5	2500
HV90 07520-2121	0.810	0.810	3.000	0.080	21	21	75	2.0	2500
HV90 10015-2121	0.810	0.810	4.000	0.060	21	21	100	1.5	2500
HV90 10020-2121	0.810	0.810	4.000	0.080	21	21	100	2.0	2500
HV90 10030-2121	1.000	1.000	4.000	0.120	25	25	100	3.0	1000
HV90 15015-2525	1.000	1.000	6.000	0.060	25	25	150	1.5	2500
HV90 15020-2525	1.000	1.000	6.000	0.080	25	25	150	2.0	2500
HV90 15030-2525	1.000	1.000	6.000	0.120	25	25	150	3.0	1000
HV90 15045-2525	1.000	1.000	6.000	0.180	25	25	150	4.5	500
HV90 15060-2525	1.000	1.000	6.000	0.250	25	25	150	6.0	500
HV90 20020-2525	1.000	1.000	8.000	0.080	25	25	200	2.0	2500
HV90 20030-2525	1.000	1.000	8.000	0.120	25	25	200	3.0	1000
HV90 20060-2525	1.000	1.000	8.000	0.250	25	25	200	6.0	500
HV90 25030-2525	1.000	1.000	10.000	0.120	25	25	250	3.0	1000
HV90 30030-2525	1.000	1.000	12.000	0.120	25	25	300	3.0	500
HV90 30045-2525	1.000	1.000	12.000	0.180	25	25	300	4.5	250
HV90 30060-2525	1.000	1.000	12.000	0.250	25	25	300	6.0	250
HV90 37520-2525	1.000	1.000	15.000	0.080	25	25	375	2.0	1000
HV90 45020-2525	1.000	1.000	18.000	0.080	25	25	450	2.0	1000
HV90 45045-2525	1.000	1.000	18.000	0.180	25	25	600	2.0	1000
HV90 60020-2525	1.000	1.000	24.000	0.080	25	25	450	4.5	250
HV90 60030-2525	1.000	1.000	24.000	0.120	25	25	600	3.0	250
HV90 75030-2525	1.000	1.000	30.000	0.120	25	25	750	3.0	250

Current pricing and additional sizes available at [www.epsi.com](http://www.epsi.com)

Not all sizes are available in all warehouse locations - please check with your local sales rep for lead time and availability



# HC

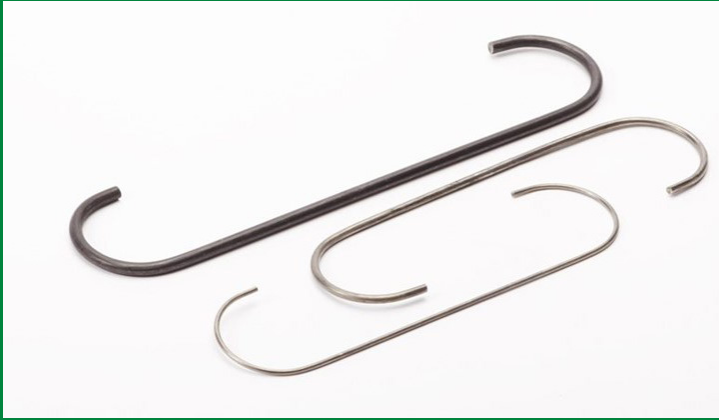

## C-Hooks

- » Can be used in combination to daisy chain multiple items together
- » Ideal for wider parts or multiple styles of parts with varying thicknesses

### Explanation of Hook Product Numbers: (ie; HC 15045-38)

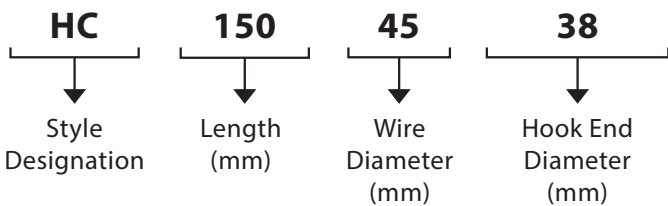

### HOOK LOADING COMPARISON (2X SAFETY FACTOR)

Round Wire			
0.062"	1.575 mm	DIAMETER HD SPRING WIRE	4 LBS
0.076"	1.930 mm	DIAMETER HD SPRING WIRE	7 LBS
0.120"	3.048 mm	DIAMETER HD SPRING WIRE	25 LBS
0.180"	4.572 mm	DIAMETER HD SPRING WIRE	75 LBS
0.250"	6.350 mm	DIAMETER CRS 1008 WIRE	60 LBS

HD=Hard Drawn CRS=Cold Rolled Steel

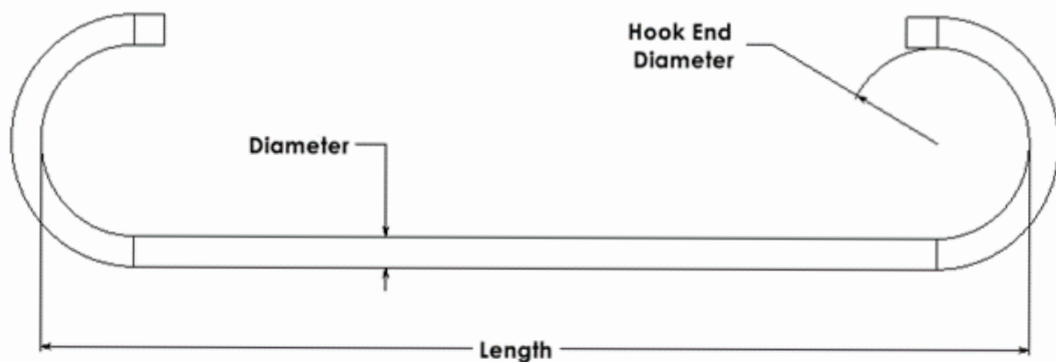

NOTE: The recommended safe load limits were compiled under static load conditions in a laboratory fully accredited by the American Association for Laboratory Accreditation, conforming to ISO Guide 25. Although all load limits incorporate a safety factor, many factors will affect the actual dynamic load capacity of a hook. Such factors include sudden change in line speed, vibration in the conveyor, or in the case of suspension from two hooks, a shift in the center of gravity caused by an incline or stretching along curves in the conveyor. This product should be tested to determine the suitability for its intended use.

\* Please call your EPSI representative for further details.

Part number	Diameter (in)	Length (in)	Hook End Diameter (in)	Diameter (mm)	Length (mm)	Hook End Diameter (mm)	Box Qty
HC 07515-32	0.060	3.0	1.250	1.5	75	32	2500
HC 07520-32	0.080	3.0	1.250	2.0	75	32	2500
HC 10015-32	0.060	4.0	1.250	1.5	100	32	2500
HC 10020-32	0.080	4.0	1.250	2.0	100	32	2500
HC 10030-32	0.120	4.0	1.250	3.0	100	32	1000
HC 15015-38	0.060	6.0	1.500	1.5	150	38	2500
HC 15020-38	0.080	6.0	1.500	2.0	150	38	2500
HC 15030-38	0.120	6.0	1.500	3.0	150	38	1000
HC 15045-38	0.180	6.0	1.500	4.5	150	38	500
HC 15060-38	0.250	6.0	1.500	6.0	150	38	250
HC 20020-38	0.080	8.0	1.500	2.0	200	38	2500
HC 20030-38	0.120	8.0	1.500	3.0	200	38	1000
HC 20045-38	0.180	8.0	1.500	4.5	200	38	500
HC 25020-38	0.080	10.0	1.500	2.0	250	38	2500
HC 25030-38	0.120	10.0	1.500	3.0	250	38	1000
HC 30020-38	0.080	12.0	1.500	2.0	300	38	1000
HC 30030-38	0.120	12.0	1.500	3.0	300	38	500
HC 30045-38	0.180	12.0	1.500	4.5	300	38	250
HC 30060-38	0.250	12.0	1.500	6.0	300	38	250
HC 37520-38	0.080	15.0	1.500	2.0	375	38	1000
HC 45030-38	0.120	18.0	1.500	3.0	450	38	500
HC 45045-38	0.180	18.0	1.500	4.5	450	38	250
HC 45060-38	0.250	18.0	1.500	6.0	450	38	125

Current pricing and additional sizes available at [www.epsi.com](http://www.epsi.com)

Not all sizes are available in all warehouse locations - please check with your local sales rep for lead time and availability

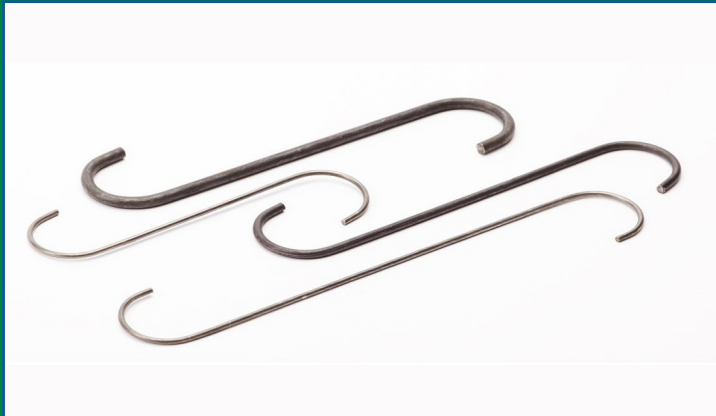

## S-Hooks

- » Can be used in combination to daisy chain multiple items together
- » Ideal for wider parts or multiple styles of parts with varying thicknesses

### Explanation of Hook Product Numbers: (ie; HS 15045-38)

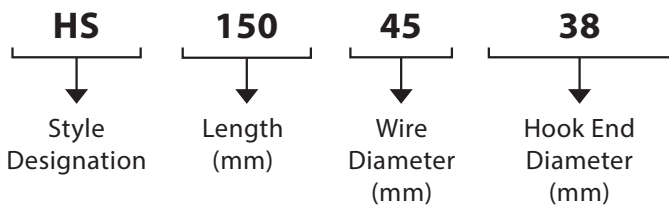

### HOOK LOADING COMPARISON (2X SAFETY FACTOR)

Round Wire			
0.062"	1.575 mm	DIAMETER HD SPRING WIRE	4 LBS
0.076"	1.930 mm	DIAMETER HD SPRING WIRE	7 LBS
0.120"	3.048 mm	DIAMETER HD SPRING WIRE	25 LBS
0.180"	4.572 mm	DIAMETER HD SPRING WIRE	75 LBS
0.250"	6.350 mm	DIAMETER CRS 1008 WIRE	60 LBS

HD=Hard Drawn CRS=Cold Rolled Steel

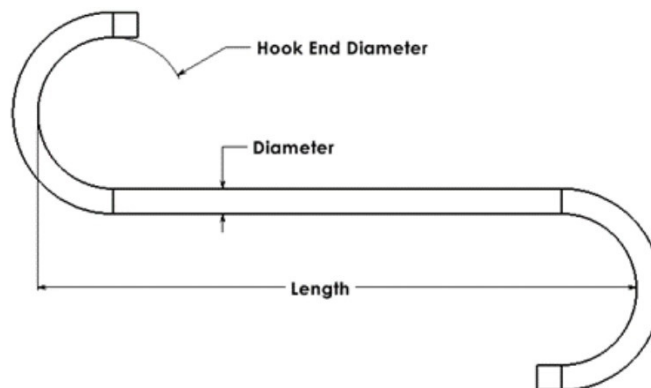

NOTE: The recommended safe load limits were compiled under static load conditions in a laboratory fully accredited by the American Association for Laboratory Accreditation, conforming to ISO Guide 25. Although all load limits incorporate a safety factor, many factors will affect the actual dynamic load capacity of a hook. Such factors include sudden change in line speed, vibration in the conveyor, or in the case of suspension from two hooks, a shift in the center of gravity caused by an incline or stretching along curves in the conveyor. This product should be tested to determine the suitability for its intended use.

\* Please call your EPSI representative for further details.

Part number	Diameter (in)	Length (in)	Hook End Diameter (in)	Diameter (mm)	Length (mm)	Hook End Diameter (mm)	Box Qty
HS 07515-32	0.060	3.000	1.250	1.5	75	32	2500
HS 10015-32	0.060	4.000	1.250	1.5	100	32	2500
HS 10020-32	0.080	4.000	1.250	2.0	100	32	2500
HS 10030-32	0.120	4.000	1.250	3.0	100	32	1000
HS 15015-38	0.060	6.000	1.500	1.5	150	38	2500
HS 15020-38	0.080	6.000	1.500	2.0	150	38	2500
HS 15030-38	0.120	6.000	1.500	3.0	150	38	1000
HS 15045-38	0.180	6.000	1.500	4.5	150	38	500
HS 15060-38	0.250	6.000	1.500	6.0	150	38	250
HS 20020-38	0.080	8.000	1.500	2.0	200	38	2500
HS 20030-38	0.120	8.000	1.500	3.0	200	38	1000
HS 20045-38	0.180	8.000	1.500	4.5	200	38	500
HS 20060-38	0.250	8.000	1.500	6.0	200	38	500
HS 25020-38	0.080	10.000	1.500	2.0	250	38	2500
HS 25030-38	0.120	10.000	1.500	3.0	250	38	1000
HS 25060-38	0.250	10.000	1.500	6.0	250	38	250
HS 30020-38	0.080	12.000	1.500	2.0	300	38	1000
HS 30030-38	0.120	12.000	1.500	3.0	300	38	500
HS 30045-38	0.180	12.000	1.500	4.5	300	38	250
HS 30060-38	0.250	12.000	1.500	6.0	300	38	250
HS 45045-38	0.180	18.000	450	4.5	450	38	250
HS 45060-38	0.250	18.000	450	6.0	450	38	125

Current pricing and additional sizes available at [www.epsi.com](http://www.epsi.com)

Not all sizes are available in all warehouse locations - please check with your local sales rep for lead time and availability

# HCV

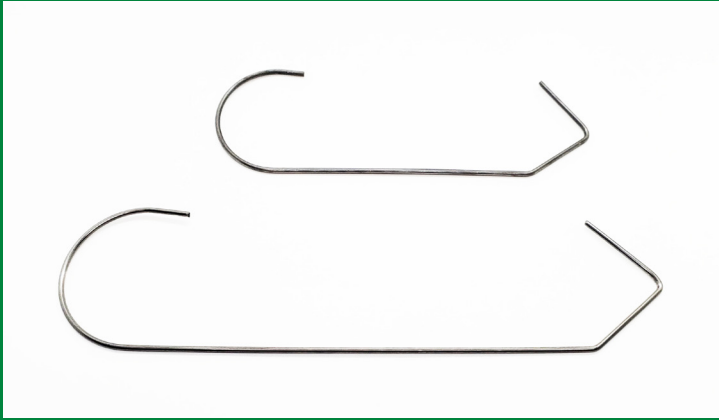

## HCV-Hook

- » Hybrid hook configuration
- » Combines the features of a V-hook with the ease of use of a C-hook
- » Can be used on both traditional and round stock conveyor systems
- » Offers the greatest load capacity with the smallest amount of hook marking

### Explanation of Hook Product Numbers: (ie; HCV 15045-32)

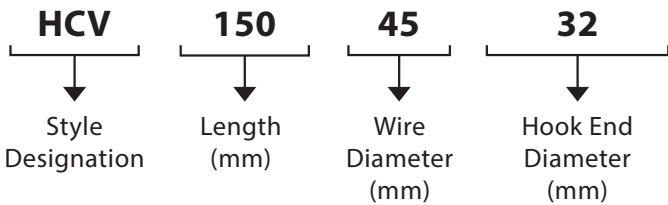

### HOOK LOADING COMPARISON (2X SAFETY FACTOR)

Round Wire			
0.062"	1.575 mm	DIAMETER HD SPRING WIRE	4 LBS
0.076"	1.930 mm	DIAMETER HD SPRING WIRE	7 LBS
0.120"	3.048 mm	DIAMETER HD SPRING WIRE	25 LBS
0.180"	4.572 mm	DIAMETER HD SPRING WIRE	75 LBS
0.250"	6.350 mm	DIAMETER CRS 1008 WIRE	60 LBS

HD=Hard Drawn CRS=Cold Rolled Steel

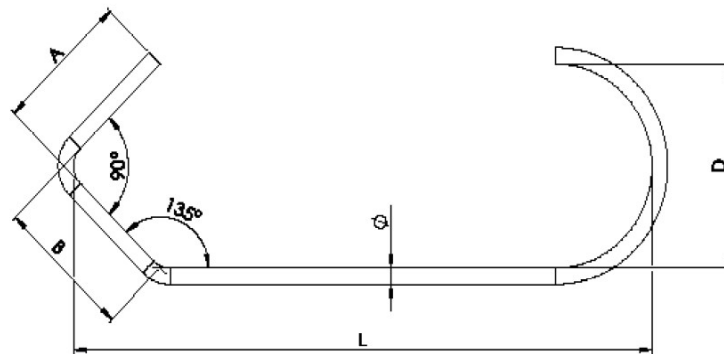

NOTE: The recommended safe load limits were compiled under static load conditions in a laboratory fully accredited by the American Association for Laboratory Accreditation, conforming to ISO Guide 25. Although all load limits incorporate a safety factor, many factors will affect the actual dynamic load capacity of a hook. Such factors include sudden change in line speed, vibration in the conveyor, or in the case of suspension from two hooks, a shift in the center of gravity caused by an incline or stretching along curves in the conveyor. This product should be tested to determine the suitability for its intended use.

\* Please call your EPSI representative for further details.

# HCV

Part number	Diameter (in)	Length (in)	Wire Diameter (in)	Diameter (mm)	Length (mm)	Wire Diameter (mm)	Box Qty
HCV 07515-25	0.060	3.0	1.0	1.5	75	25	2500
HCV 07520-25	0.080	3.0	1.0	2.0	75	25	2500
HCV 10015-32	0.060	4.0	1.25	1.5	100	32	2500
HCV 10020-32	0.080	4.0	1.25	2.0	100	32	2500
HCV 10030-32	0.120	4.0	1.25	3.0	100	32	1000
HCV 15015-38	0.060	6.0	1.5	1.5	150	38	2500
HCV 15020-38	0.080	6.0	1.5	2.0	150	38	2500
HCV 15030-38	0.120	6.0	1.5	3.0	150	38	1000
HCV 15045-38	0.180	6.0	1.5	4.5	150	38	500
HCV 20020-38	0.080	8.0	1.5	2.0	200	38	2500
HCV 20030-38	0.120	8.0	1.5	3.0	200	38	1000
HCV 20045-38	0.180	8.0	1.5	4.5	200	38	500
HCV 25020-38	0.080	10.0	1.5	2.0	250	38	2500
HCV 25030-38	0.120	10.0	1.5	3.0	250	38	1000
HCV 25045-38	0.180	10.0	1.5	4.5	250	38	250
HCV 30030-38	0.120	12.0	1.5	3.0	300	38	500
HCV 30045-38	0.180	12.0	1.5	4.5	300	38	250
HCV 30060-38	0.250	12.0	1.5	6.0	300	38	250
HCV 37530-38	0.120	15.0	1.5	3.0	375	38	500
HCV 45030-38	0.120	18.0	1.5	3.0	450	38	500
HCV 45045-38	0.180	18.0	1.5	4.5	450	38	250
HCV 60045-38	0.180	24.0	1.5	4.5	600	38	100

Current pricing and additional sizes available at [www.epsi.com](http://www.epsi.com)

Not all sizes are available in all warehouse locations - please check with your local sales rep for lead time and availability



# HKD

## Diamond Hooks

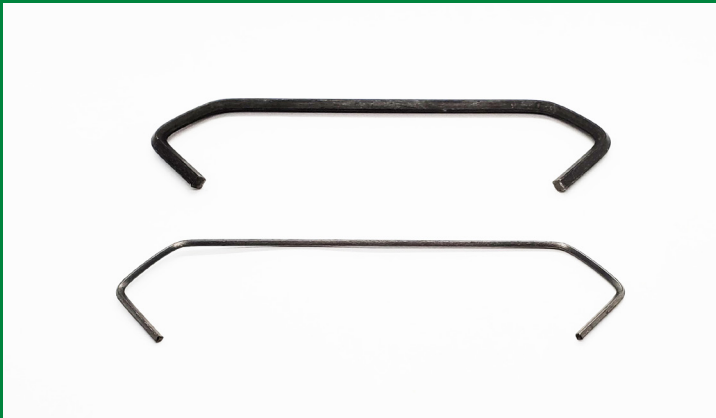

- » Sharp edge provides better current flow
- » Smaller contact patch minimizes rework due to touch-ups
- » Almost double the load of V-style and C-style hooks

### Explanation of Hook Product Numbers: (ie; HKD 010016)

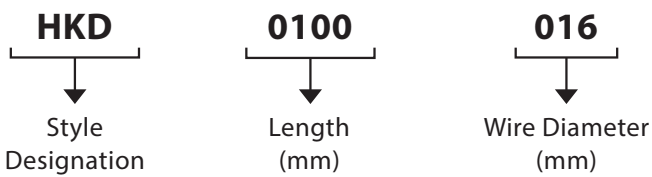

### HOOK LOADING COMPARISON (2X SAFETY FACTOR)

Round Wire			
0.059"	1.499 mm	HD SPRING WIRE	9 LBS
0.118"	2.997 mm	HD SPRING WIRE	60 LBS
0.177"	4.496 mm	HD SPRING WIRE	180 LBS

*HD=Hard Drawn CRS=Cold Rolled Steel*

UNITS: INCHES	"A" WIRE (FLAT TO FLAT)	"B" LENGTH (in)	"C" LEG LENGTHS (in)	LOAD (LBS)	QTY /BOX
HKD 010016	0.060	4.0	0.64	9.0	2000
HKD 010027	0.120	4.0	0.72	60	2000
HKD 017516	0.060	7.0	0.64	9.0	2000
HKD 017527	0.120	7.0	0.72	60	1500
HKD 022530	0.120	9.0	0.73	60	1000
HKD 022546	0.180	9.0	0.81	180	500
HKD 030030	0.120	12.0	0.73	60	500
HKD 030046	0.180	12.0	0.81	180	250
HKD 037530	0.120	15.0	0.73	60	500
HKD 037546	0.180	15.0	0.81	180	250
HKD 045030	0.120	18.0	0.73	60	500
HKD 045046	0.180	18.0	0.81	180	250
HKD 052530	0.120	21.0	0.73	60	500
HKD 052546	0.180	21.0	0.81	180	250
HKD 060030	0.120	24.0	0.73	60	500
HKD 060046	0.180	24.0	0.81	180	250

Current pricing and additional sizes available at [www.epsi.com](http://www.epsi.com)  
Not all sizes are available in every warehouse location - please check with your local sales rep for lead time and availability



## V-Style Locking Hooks



- » Designed to fit around contact points of most suspension systems and rods
- » Locking eyelet design ensures that hook will not fall off of beams

### Explanation of Hook Product Numbers: (ie; HKVL 375080-6)

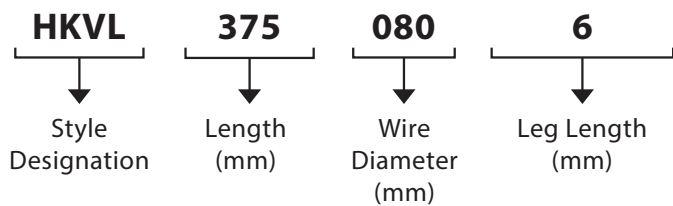

### HOOK LOADING COMPARISON (2X SAFETY FACTOR)

Round Wire			
0.062"	1.575 mm	DIAMETER HD SPRING WIRE	4 LBS
0.076"	1.930 mm	DIAMETER HD SPRING WIRE	7 LBS
0.120"	3.048 mm	DIAMETER HD SPRING WIRE	25 LBS
0.180"	4.572 mm	DIAMETER HD SPRING WIRE	75 LBS
0.250"	6.350 mm	DIAMETER CRS 1008 WIRE	60 LBS

HD=Hard Drawn CRS=Cold Rolled Steel

Part number	Diameter (in)	Length (in)	Rod Diameter (in)	Diameter (mm)	Length (mm)	Box Qty
HKVL 188060-2	0.060	2.000	3/16	1.5	50	2500
HKVL 188060-4	0.060	4.000	3/16	1.5	100	2500
HKVL 250060-2	0.060	2.000	1/4	1.5	50	2500
HKVL 250060-4	0.060	4.000	1/4	1.5	100	2500
HKVL 250060-6	0.060	6.000	1/4	1.5	150	2500
HKVL 375044-4	0.040	4.000	3/8	1.0	100	2500
HKVL 375060-4	0.060	4.000	3/8	1.5	100	2500
HKVL 375080-2	0.080	2.000	3/8	2.0	50	2500
HKVL 375080-4	0.080	4.000	3/8	2.0	100	2500
HKVL 375080-6	0.080	6.000	3/8	2.0	150	2500

Current pricing and additional sizes available at [www.epsi.com](http://www.epsi.com)

Not all sizes are available in all warehouse locations - please check with your local sales rep for lead time and availability

# CLAW

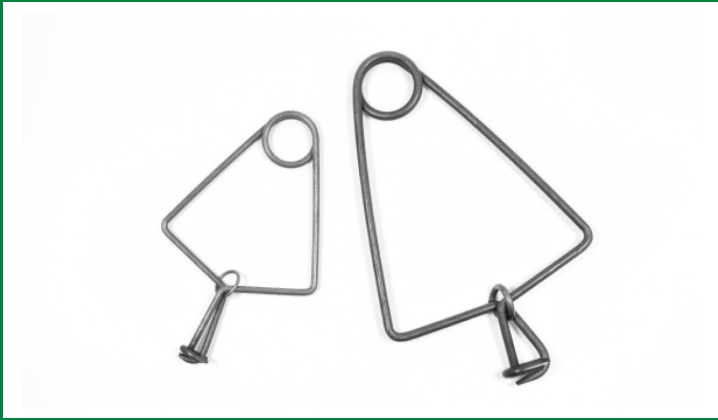

## Claw Hooks

- » Designed to handle the most unusual of hanging situations
- » Their unique clamping action and strong contact points allow even the most unconventional of items to be hung
- » Three different sizes available:
  - Claw 200 – light loads up to 5 lbs
  - Claw 300 – medium loads up to 10 lbs
  - Claw 400 – heavy loads to 40 lbs

Part number	Length (in)	Wire Diameter (in)	Length (mm)	Wire Diameter (mm)	Prongs	Box Qty
CLAW 200	2.400	0.080	60	2.0	3	50
CLAW 300	4.800	0.120	120	3.0	3	50
CLAW 400	6.500	0.160	165	4.0	3	50

Current pricing and additional sizes available at [www.epsi.com](http://www.epsi.com)

Not all sizes are available in all warehouse locations - please check with your local sales rep for lead time and availability

# SWIVEL



## Swivel Hook

- » Cold rolled steel construction
- » Holds up to 250 lbs
- » Ball bearings ensure smooth rotation even under loading
- » Features a V-shaped (Swivel V) or a radial (Swivel R) hanging point

Part number	Load Capacity (lbs)	Load Capacity (kg)	Rotation	Box Qty
SWIVEL (R)	250	110	Infinite	2
SWIVEL (V)	250	110	Infinite	2

Current pricing and additional sizes available at [www.epsi.com](http://www.epsi.com)

Not all sizes are available in all warehouse locations - please check with your local sales rep for lead time and availability

# HKSC

## Sheet & Pipe Suspender Hook



- » Made of cold rolled steel
- » Reusable
- » Suitable for products that lack holes for suspension
- » Accept sheet metal up to 4.0 mm (0.160") thick
- » Has holes for use with standard hooks for easy hanging



Part number	Standard Thickness (in)	Metric Thickness (mm)	Box Qty
HKSC 002040	0.080	2.0	50

Current pricing and additional sizes available at [www.epsi.com](http://www.epsi.com)

Not all sizes are available in all warehouse locations - please check with your local sales rep for lead time and availability



## Spring Tube Hooks

- » Easy to apply
- » Allows for hook marks to be hidden inside of holes and other non-cosmetic features
- » Flexible enough to fit a variety of otherwise difficult applications
- » Available in three different sizes

Part number	Length (in)	Wire Diameter (in)	Length (mm)	Wire Diameter (mm)	Box Qty
HKRO 100	1.770	0.040	45	1.0	250
HKRO 200	4.130	0.080	105	2.0	250
HKRO 300	4.250	0.120	108	3.0	250

Current pricing and additional sizes available at [www.epsi.com](http://www.epsi.com)

Not all sizes are available in all warehouse locations - please check with your local sales rep for lead time and availability

# Custom Wire Forms

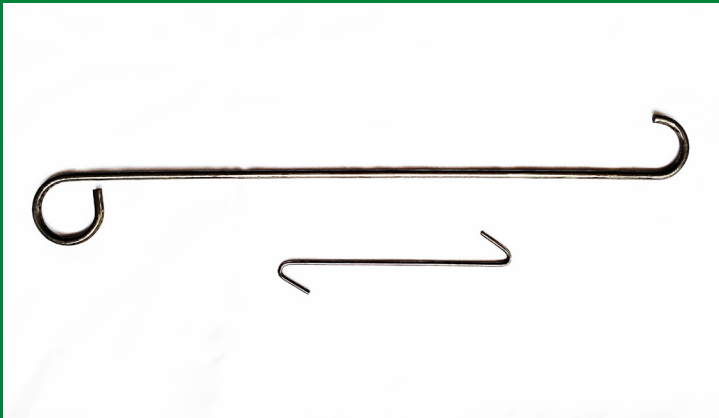

Are you spending too much on masking labor?  
Is your line speed suffering due to complicated coating processes?  
Do you want to reduce your 3P cost (per painted part)?  
If so, custom wire forms from EPSI is for you!

EPSI is proud to offer custom hooks and hanging solutions. Our in-house engineering team possesses over a decade of experience in partnering with clients towards the production of tens of thousands of custom hooks

We continually lead the industry in creating efficient, custom wire form and hanging solutions that cater to diverse applications.

At EPSI, our custom process commences by gathering all relevant data from the client, including drawings, samples, and any other pertinent information.

Through a comprehensive consultation process, we discuss and determine the most suitable wire form or hanging method to utilize. Our ultimate goal is to produce a final product that aligns with the client's precise requirements and specifications.

Custom wire forms can be made as small as 0.060" in wire diameter and up to 3/4" in wire diameter. You choose the wire style and material that best fits your applications needs!

Go Custom with EPSI and SAVE!



# ST



## Silicone Tubing

Heat resistant up to 600°F (315°C)

Material: Silicone

- » When sizing parts as a sleeve, the ID of the ST Tubing should be approximately equal to the stud diameter
- » To ensure easy removal, cut the tube length at least 1/2" longer than masking length of the stud. This is especially important if the tube ID is smaller than the stud diameter by more than 2%
- » When sizing parts as a plug, the OD should be 3 - 7% larger than the hole diameter
- » Due to the low tear resistance of silicone, do not use pliers or other sharp tools for removal
- » Can be used in conjunction with a standard cap to create a long, non-hollow cap

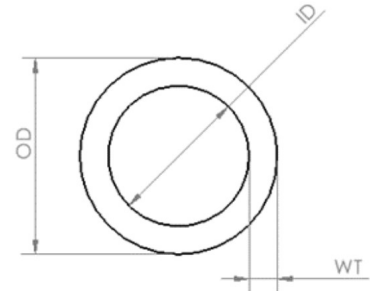



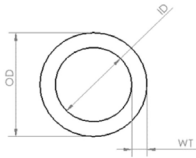

# ST

Part number	ID (in)	OD (in)	WT (in)	ID (mm)	OD (mm)	WT (mm)	Roll Length (ft)
ST 0109	0.109	0.234	0.063	2.8	5.9	1.6	100
ST 0125	0.125	0.250	0.063	3.2	6.4	1.6	100
ST 0140	0.140	0.265	0.063	3.6	6.7	1.6	100
ST 0156	0.156	0.281	0.063	4.0	7.1	1.6	100
ST 0187	0.187	0.312	0.063	4.7	7.9	1.6	100
ST 0203	0.203	0.328	0.063	5.2	8.3	1.6	100
ST 0218	0.218	0.343	0.063	5.5	8.7	1.6	100
ST 0234	0.234	0.359	0.063	5.9	9.1	1.6	100
ST 0250	0.250	0.375	0.063	6.4	9.5	1.6	100
ST 0281	0.281	0.406	0.063	7.1	10.3	1.6	50
ST 0312	0.312	0.437	0.063	7.9	11.1	1.6	50
ST 0343	0.343	0.468	0.063	8.7	11.9	1.6	50
ST 0375	0.375	0.500	0.063	9.5	12.7	1.6	50
ST 0406	0.406	0.531	0.063	10.3	13.5	1.6	50
ST 0437	0.437	0.562	0.063	11.1	14.3	1.6	50
ST 0500	0.500	0.625	0.063	12.7	15.9	1.6	50
ST 0625	0.625	0.750	0.063	15.9	19.1	1.6	50
ST 0750	0.750	0.875	0.063	19.1	22.2	1.6	50
ST 0875	0.875	1.000	0.063	22.2	25.4	1.6	50
ST 1000	1.000	1.125	0.063	25.4	28.6	1.6	50
ST 1125	1.125	1.250	0.063	28.6	31.8	1.6	25
ST 1250	1.250	1.375	0.063	31.8	34.9	1.6	25
ST 1375	1.375	1.500	0.063	34.9	38.1	1.6	25
ST 1500	1.500	1.625	0.063	38.1	41.3	1.6	25
ST 1625	1.625	1.750	0.063	41.3	44.5	1.6	25
ST 1750	1.750	1.875	0.063	44.5	47.6	1.6	25
ST 1875	1.875	2.000	0.063	47.6	50.8	1.6	25
ST 2000	2.000	2.125	0.063	50.8	54.0	1.6	25

Current pricing and additional sizes available at [www.epsi.com](http://www.epsi.com)

Not all sizes are available in all warehouse locations - please check with your local sales rep for lead time and availability



# FSTS



## Flexible Star Tubing

Heat resistant up to 600°F (315°C)

Material: Silicone

- » Fits over threaded studs, dowels, pins and tube stock
- » Each size fits multiple diameters
- » Low friction for easy placement and removal
- » Flexible enough to conform to irregular geometries
- » Cuts easily to length
- » When sizing product as a sleeve, the Major ID of the FSTS tubing should be approximately equal to the stud or tube diameter you are sliding it over

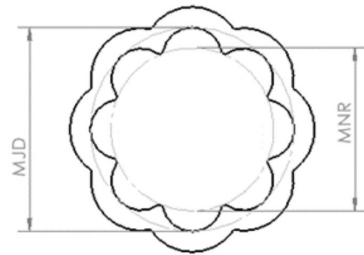

Part number	Color	MNR (in)	MJD (in)	Application Range (in)	MNR (mm)	MJD (mm)	Application Range (mm)	Roll Length (ft)
FSTS 0200-W	white	0.200	0.250	0.200 - 0.250	5.1	6.4	5.1 - 6.4	100
FSTS 0300-F	rusty	0.300	0.375	0.300 - 0.375	7.6	9.5	7.6 - 9.5	100
FSTS 0400-L	yellow	0.400	0.500	0.400 - 0.500	10.2	12.7	10.2 - 12.7	100
FSTS 0500-P	purple	0.500	0.625	0.500 - 0.625	12.7	15.9	12.7 - 15.9	100
FSTS 0625-F	rusty	0.625	0.750	0.625 - 0.750	15.9	19.1	15.9 - 19.1	50
FSTS 0725-U	blue	0.725	0.875	0.725 - 0.875	18.4	22.2	18.4 - 22.2	50
FSTS 0850-W	white	0.850	1.000	0.850 - 1.000	21.6	25.4	21.6 - 25.4	50
FSTS 1000-C	clear	1.000	1.250	1.000 - 1.250	25.4	31.8	25.4 - 31.8	25
FSTS 1250-P	purple	1.250	1.500	1.250 - 1.500	31.8	38.1	31.8 - 38.1	25
FSTS 1500-F	rusty	1.500	1.750	1.500 - 1.750	38.1	44.5	38.1 - 44.5	25
FSTS 1750-O	orange	1.750	2.000	1.750 - 2.000	44.5	50.8	44.5 - 50.8	25

Current pricing and additional sizes available at [www.epsi.com](http://www.epsi.com)

Not all sizes are available in all warehouse locations - please check with your local sales rep for lead time and availability

# CRDS



## Solid Silicone Cord

Heat resistant up to 600°F (315°C)

Material: Silicone

- » Plug exposed channels or grooves on machined parts
- » Used to plug threaded and non-threaded holes
- » Cuts easily to length
- » To ensure tight seal, pick a product whose outer diameter (OD) dimension is at least 3-7% larger than the hole or groove that is being masked

Part number	Color	Diameter (in)	Diameter (in)	Diameter (mm)	Roll Length (ft)
CRDS 0063-R	red	0.063	1/16	1.6	100
CRDS 0125-O	orange	0.125	1/8	3.2	100
CRDS 0188-P	purple	0.188	3/16	4.8	100
CRDS 0250-N	pink	0.250	1/4	6.4	100
CRDS 0375-R	rede	0.375	3/8	9.5	50
CRDS 0500-P	purple	0.500	1/2	12.7	50

Current pricing and additional sizes available at [www.epsi.com](http://www.epsi.com)

Not all sizes are available in all warehouse locations - please check with your local sales rep for lead time and availability

# CRDF



## Silicone Foam Cord

Heat resistant up to 600°F (315°C)

Material: Silicone foam

- » Elongate the cord during application to make insertion easy. Cord will return back to original shape when released and create a liquid tight seal
- » To ensure a liquid tight seal, pick a product whose outer diameter (OD) dimension is 3 - 7% larger than the hole or groove that is being masked
- » Compresses to seal off slots and through holes
- » Conforms to irregular shaped openings
- » Cuts easily to length
- » Color coded for easy identification

Part number	Color	Diameter (in)	Diameter (in)	Diameter (mm)	Roll Length (ft)
CRDF 0062-G	green	0.062	1/16	1.6	50
CRDF 0125-B	black	0.125	1/8	3.2	50
CRDF 0187-R	red	0.187	3/16	4.7	50
CRDF 0250-Y	grey	0.250	1/4	6.4	50
CRDF 0312-U	blue	0.312	5/16	7.9	50
CRDF 0500-O	orange	0.500	1/2	12.7	25
CRDF 0625-Y	grey	0.625	5/8	15.9	25
CRDF 0750-R	red	0.750	3/4	19.1	25
CRDF 0875-Y	grey	0.875	7/8	22.2	25
CRDF 1000-U	blue	1.000	1	25.4	25

Current pricing and additional sizes available at [www.epsi.com](http://www.epsi.com)

Not all sizes are available in all warehouse locations - please check with your local sales rep for lead time and availability



# SHFS



## Silicone Foam Sheeting

Heat resistant up to 600°F (315°C)

Material: Silicone

- » Silicone foam is more conformable and lighter in weight than solid silicone rubber
- » Silicone foam's fabric-like top film is extremely durable and resists powder build-up
- » Saves labor time over traditional tape masking, and can be reused for additional cost savings
- » Foam sheeting is a closed-cell structure and will not absorb water
- » Can be custom cut to your specific design requirements
- » Reusable paint mask
- » Foam sheeting (SHFS) is conformable and lightweight

## Silicone Foam

Part number	Standard L x W (in)	Standard Thickness (in)	Standard Thickness (in)	Metric Thickness (mm)	Standard L x W (mm)
SHFS 0032	36 X 36	0.125	1/8	3.2	914 X 914
SHFS 0064	36 X 36	0.250	1/4	6.4	914 X 914
SHFS 0127	36 X 36	0.500	1/2	12.7	914 X 914

Current pricing and additional sizes available at [www.epsi.com](http://www.epsi.com)

Not all sizes are available in all warehouse locations - please check with your local sales rep for lead time and availability



# SHRS



## Solid Silicone Sheeting

Heat resistant up to 600°F (315°C)

Material: Silicone

- » Silicone rubber has a smooth surface where as silicone foam has a textured surface
- » Saves labor time over traditional tape masking, and can be reused for additional cost savings
- » Can be custom cut to your specific design requirements
- » Reusable paint mask
- » Solid rubber (SHRS) is ideal for gaskets in sealing application or can be used as a cushion to protect your products from costly scratches

## Solid Silicone Rubber

Part number	Standard L x W (in)	Standard Thickness (in)	Standard Thickness (in)	Metric Thickness (mm)	Standard L x W (mm)
SHRS 0016	36 X 36	0.063	1/16	1.6	914 X 914
SHRS 0024	36 X 36	0.094	3/32	2.4	914 X 914
SHRS 0032	36 X 36	0.125	1/8	3.2	914 X 914
SHRS 0048	36 X 36	0.188	3/16	4.8	914 X 914

Current pricing and additional sizes available at [www.epsi.com](http://www.epsi.com)

Not all sizes are available in all warehouse locations - please check with your local sales rep for lead time and availability



# KIT

## Starter Kits



- » A sample selection for evaluating the appropriate size of a mask
- » Our Starter Kits contain a variety of caps and plugs in assorted sizes

Part number	Items	
KIT CONS/CONE	Silicone & EPDM CON Caps	<a href="#">more information on page 18 - 19</a>
KIT EC-1	EPDM Caps	<a href="#">more information on page 10 - 12</a>
KIT EC-2	EPDM Caps	<a href="#">more information on page 10 - 12</a>
KIT SC-1	Silicone Caps	<a href="#">more information on page 6 - 9</a>
KIT SC-2	Silicone Caps	<a href="#">more information on page 6 - 9</a>
KIT BES	Black EPDM Stoppers	<a href="#">more information on page 36 - 37</a>
KIT BTM	Blind-Hole Thread Mask Plugs	<a href="#">more information on page 42</a>
KIT CRKR	Cork Stoppers	<a href="#">more information on page 35</a>
KIT EPP	EPDM Pull Plugs	<a href="#">more information on page 48 - 49</a>
KIT FLPE	EPDM Flangless Plugs	<a href="#">more information on page 38 - 39</a>
KIT FLPS	Silicone Flangless Plugs	<a href="#">more information on page 38 - 39</a>
KIT SOMS	Sink-O-Mask Plugs	<a href="#">more information on page 56</a>
KIT SPP-1	Silicone Pull Plugs	<a href="#">more information on page 45 - 47</a>
KIT SPP-2	Silicone Pull Plugs	<a href="#">more information on page 45 - 47</a>
KIT STS-1	Silicone Tapered Stoppers	<a href="#">more information on page 30 - 32</a>
KIT STS-2	Silicone Tapered Stoppers	<a href="#">more information on page 30 - 32</a>
KIT TNM	Thread-N-Mask Plugs	<a href="#">more information on page 59</a>
KIT WP	Washer Plugs	<a href="#">more information on page 63 - 64</a>





## Paint Touch-Up Stick

(Powder Coating Applications - Available in Smooth & Textured Finish)

- » Need a quick and easy touch-up solution for your powder coat? EPSI has you and your part covered
- » Ideal for repairing minor damage to touch points using the powder you already have on hand
- » Measure the perfect amount of powder with the built-in dosing chamber located inside the cap
- » One stick for each color in smooth or textured finish to match your application needs
- » Reusable – Up to 3 month shelf life once mixed

Part number	Description	BAG QTY
PTS-1	Paint touch stick, smooth, 8 ml	1
PTS-2	Paint touch stick, texture, 8 ml	1

Current pricing and additional sizes available at [www.epsi.com](http://www.epsi.com)

Not all sizes are available in all warehouse locations - please check with your local sales rep for lead time and availability

# CRSP



## Cork Spacer Pads

- » Protect finished products during shipping and storage
- » Spacer pads stick without adhesive
- » Fast, easy placement and removal
- » Inexpensive cork material, reusable
- » Parts can be stacked shortly after curing

Part number	Standard Base (in)	Standard Thickness (in)	Metric Base (mm)	Metric Thickness (mm)	Box Qty
CRSP 181804	0.709 X 0.709	0.157	18.0 X 18.0	4.0	1000
CRSP 202010	0.787 X 0.787	0.394	20.0 X 20.0	10.0	500

Current pricing and additional sizes available at [www.epsi.com](http://www.epsi.com)

Not all sizes are available in all warehouse locations - please check with your local sales rep for lead time and availability



# CNC

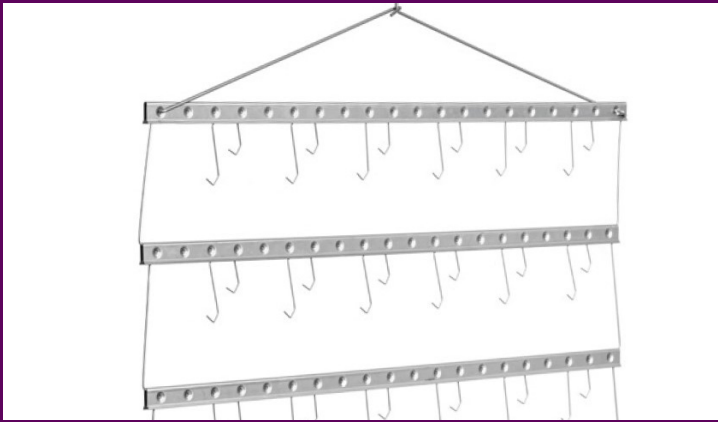

## Cross-N-Click Racking

- » Innovative crossbar system for quick and easy assembly
- » Ideal for small parts and small part production runs
- » Comes as a complete system with twin hooks (two hooks in one!) for hanging small parts
- » Customizable to accommodate various hook styles
- » Shipped as individual parts, saving time and space in transit when compared to preassembled welded frames

Part number	Crossbar Width (in)	Level Hooks (in)	Number of Levels	Quantity Twin Hooks	Box Qty
CNC-01X01	40	6 in & 10 in	4	40	1
CNC-01X03	40	6 in & 10 in	4	120	3

# MRF

## Modular Racking Frame

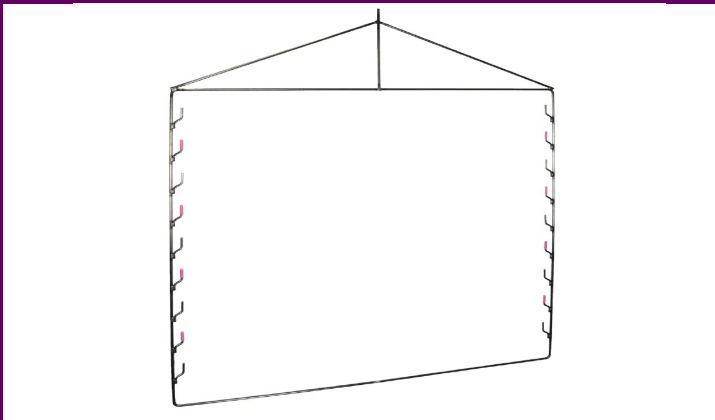

- » Modular Racking Frames offer flexible paint area options
- » Select from a wide range of XBar sizes to hang parts for maximum efficiency
- » Custom sizes are available upon request

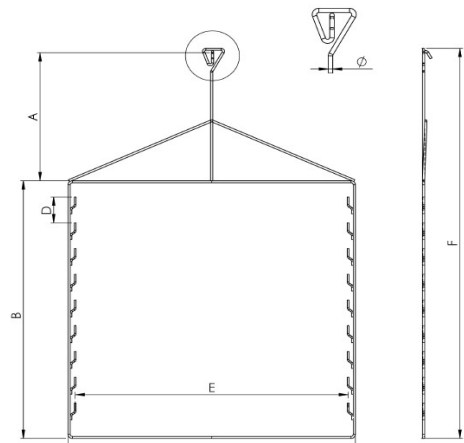

Part number	A (in)	B (in)	C (in)	D (in)	E (in)	F (in)	Dia. Hanging Hook (in)	Levels	BAG QTY
MRF-1000X1000	19.68	39.37	40.55	3.94	38.5	59.05	0.32	9	1

# BGT

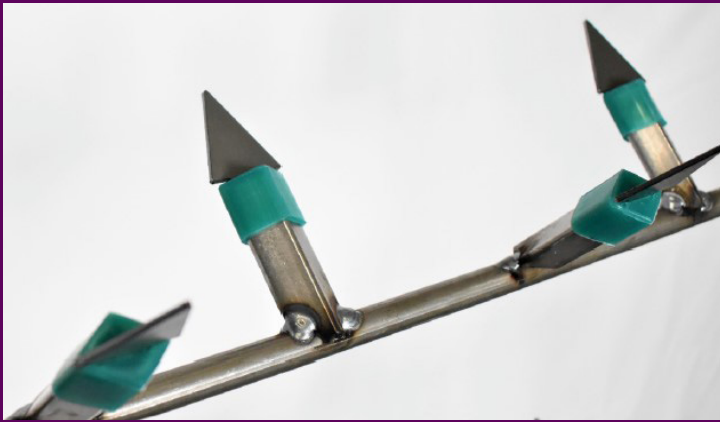

## Diamond XBar

- » Diamond XBar offers optimized grounding of components
- » Life of XBar can be taken even further with paired specially designed DRC1-G cap
- » Wide range of standard tip styles available
- » Custom sizes are available upon request

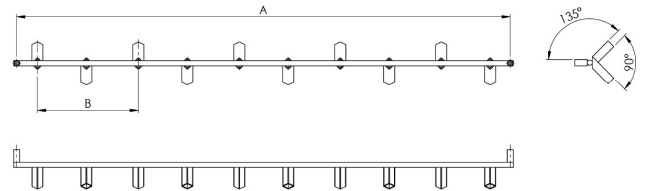

## Diamond XBar

Part number	A (in)	B (in)	Hanging Points	Box Qty
BGT-1000*10	38.5	7.87	10	1

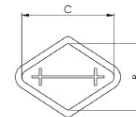

## Diamond Masking Cap

Part number	Color	A (in)	B (in)	C (in)	Box Qty
DRC1-G	green	0.87	0.62	0.85	500

# XBar Tips

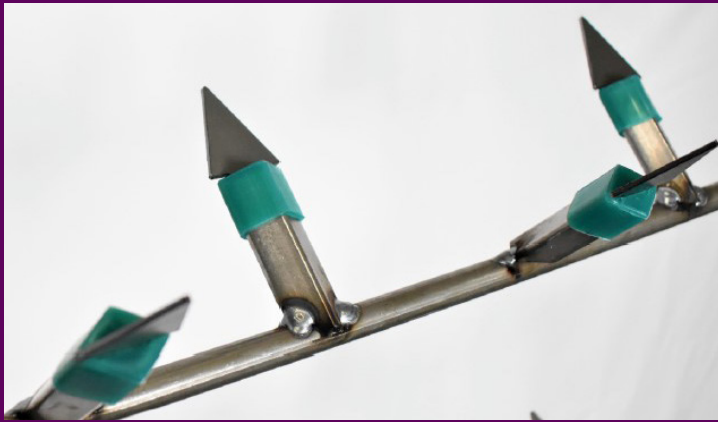

## Standard Tips for Diamond XBar

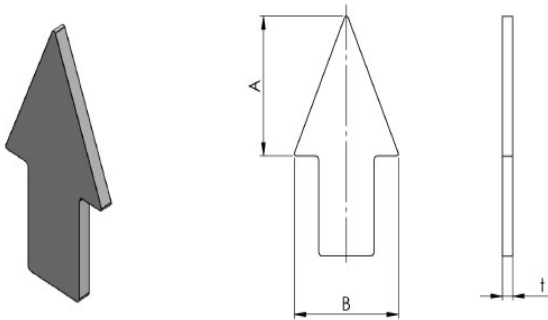

Part number	A (in)	B (in)	T (in)	Box QTY
BGE-PS-020X0030	1.38	1.18	0.08	500
BGE-PS-030X0030	1.38	1.18	0.12	500

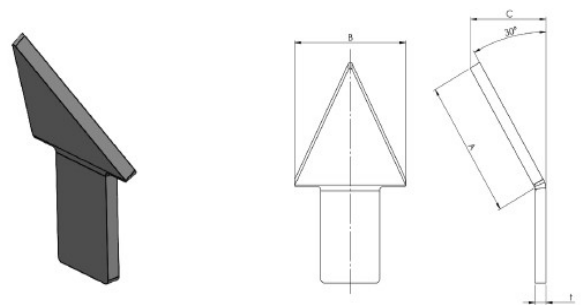

Part number	A (in)	B (in)	C (in)	T (in)	Box Qty
BGE-PS30-020X0030	1.38	1.18	0.8	0.08	500
BGE-PS30-030X0030	1.38	1.18	0.8	0.12	500

# XBar Tips



## Standard Tips for Diamond XBar

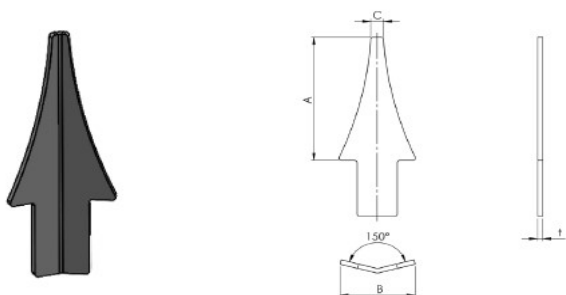

Part number	A (in)	B (in)	C (in)	T (in)	Box Qty
BGE-PSV-020X0030	2.17	1.18	0.22	0.08	500
BGE-PSV-030X0030	2.17	1.18	0.22	0.12	500

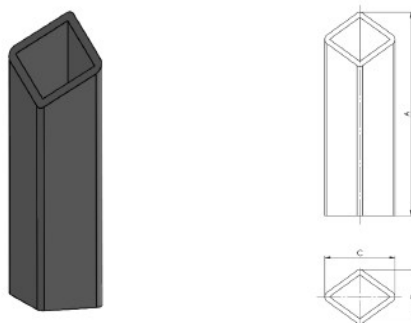

Part number	A (in)	B (in)	T (in)	Box QTY
GK-BG1	2.36	0.63	0.87	500



# HGT

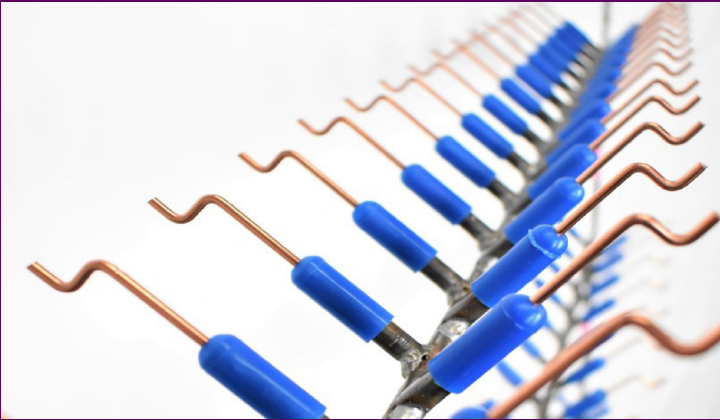

## Round XBar

- » Round XBar offers optimized grounding of components
- » Life of XBar can be taken even further with paired specially designed SCH masking cap
- » Wide range of standard tip styles available
- » Custom sizes are available upon request

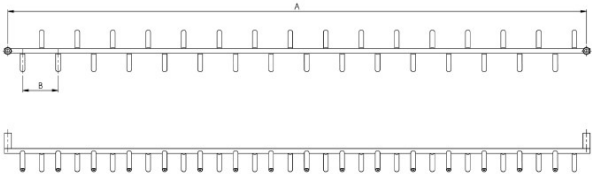

## Round XBar

Part number	A (in)	B (in)	Hanging Points	Box Qty
HGT-1000X32	38.5	2.36	32	1

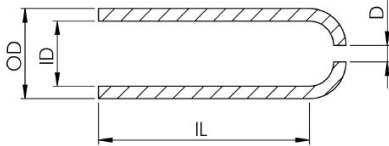

## Silicone Cap with Hole

Part number	Color	ID (in)	OD (in)	D (in)	IL (in)	Box Qty
SCH0312010-U	blue	0.31	0.43	0.04	1.0	1000
SCH0312020-U	blue	0.31	0.43	0.08	1.0	1000

# XBar Tips



## Standard Tips for Round XBar



Part number	A (in)	B (in)	C (in)	D (in)	Box Qty
HGH-020X0050	0.59	0.47	2.36	0.08	2500
HGH-030X0050	0.59	0.47	2.36	0.12	2500



Part number	A (in)	B (in)	C (in)	D (in)	Box Qty
HGS-015X0060	2.36	-	-	0.06	5000
HGS-020X0060	2.36	-	-	0.08	5000

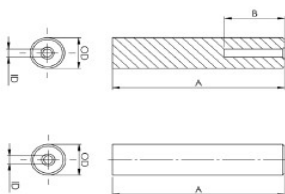

Part number	A (in)	B (in)	OD (in)	ID (in)	Box Qty
GK-HG-D8X40-2.1	1.57	0.55	0.31	0.08	1250
GK-HG-D8X40.3.1	1.57	0.55	0.31	0.12	1250

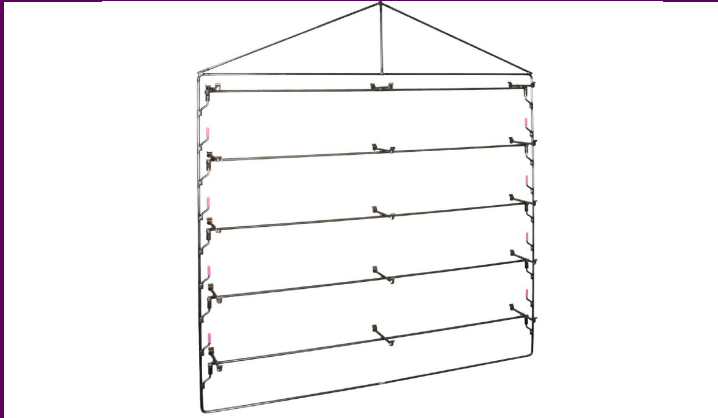

## Profile XBar

- » Our Profile XBar is specially designed to hang a wide range of part profiles
- » Narrow upturning design of the mounting plates allows for sturdy yet flexible support for components

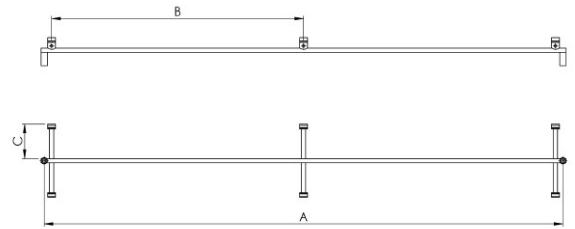

## Profile XBar

Part number	A (in)	B (in)	C (in)	Hanging Points	Box Qty
PLT-1000X06	38.5	18.7	2.55	6	1

# SB

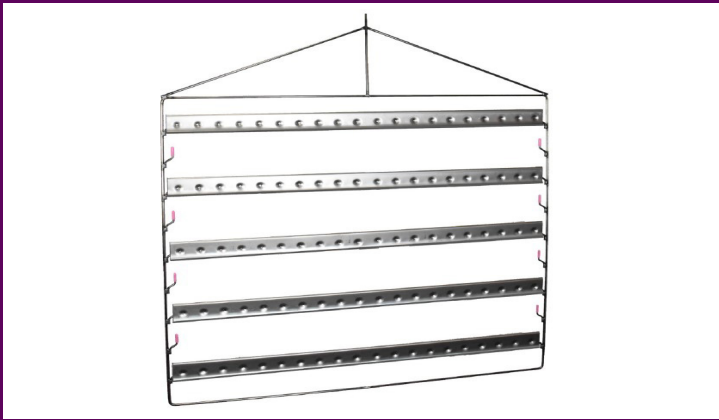

## SB Crossbar

- » Standard SB Crossbar offers flexible hanging points for varying hook diameters
- » This crossbar is compatible with all standard hooks sizes
- » Special design offers optimal contact with the formation of a faraday cage (shield)

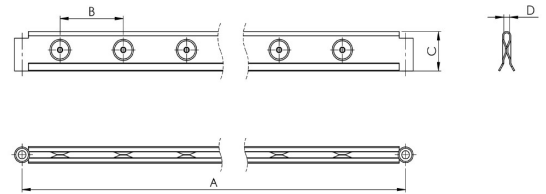

## Crossbar with Hanging Rod

Part number	A (in)	B (in)	C (in)	D (in)	Max Hook Dia	Hanging Points	Box Qty
SB1-MRF-1000X050	38.5	1.97	1.18	0.18	0.15	19	1

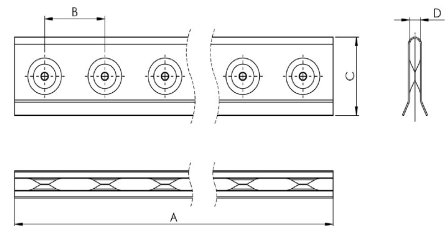

## Crossbar

Part number	A (in)	B (in)	C (in)	D (in)	Max Hook Dia	Hanging Points	Box Qty
SB1-1000X050	39.37	1.97	1.18	0.18	0.15	20	1
SB2-1000X050	39.37	1.97	2.36	0.35	0.23	20	1



# Custom Racking



## Why Choose EPSI?

EPSI is the undisputed leader in providing finishing and painting solutions. Our 75 years of experience have earned us an unbeatable reputation in the industry. We take pride in being the largest builder of custom racks, baskets, and fixtures.

Our products are designed and manufactured to meet your specific requirements, and we rebuild fixtures to like-new condition. We create custom metal and plastic fabrications that are unmatched in quality and durability.

Our team of industry experts can optimize your equipment's capabilities by designing tools that consider space utilization, loading/unloading efficiency, and ergonomics. We offer solutions for industry standards including OSHA, 5s, Lean Management, and ISO.

You can expect highly personalized service from our team of professionals who are committed to meeting your needs.

## Expansion into Racking/Tooling

- » Acquired **An-Kor Rack** in Milwaukee, WI in 2019
- » Acquired **Associated Rack Corporation** (included 6 mfg. locations) in 2021
- » Acquired **Custom Rack** in Euless, TX in 2022
- » Acquired **Filter** in Germany in 2022

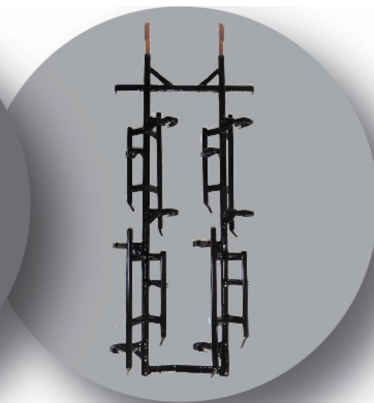
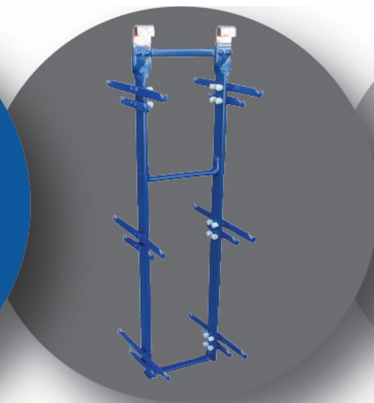
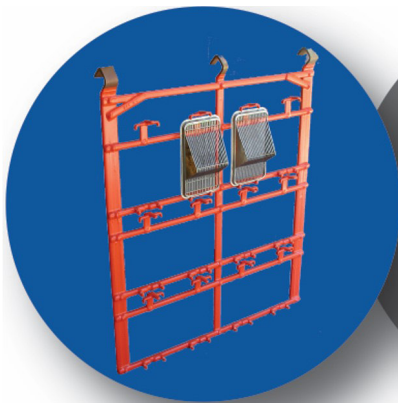

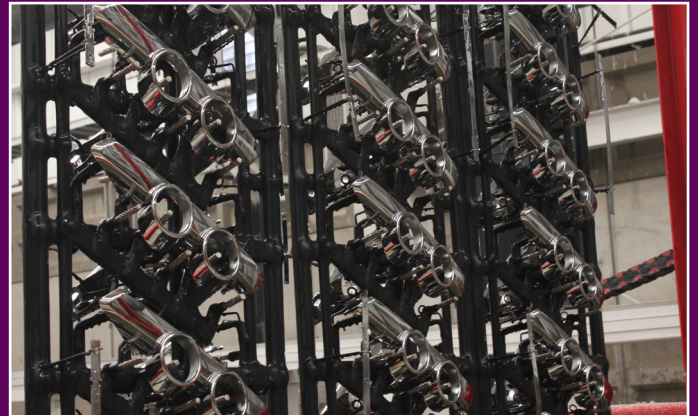

## Custom Tooling and Fabrication

### Anodizing Racks

- » Custom Tooling for Type I, Type II, and Type III Anodizing
- » Manufactured with Aluminum, Titanium, or a combination of both metals
- » Platisol Coated or Uncoated
- » Designed with Current Requirements, Part Hold and Fit, and Ergonomic Items Considered
- » Servicing Aerospace and other Industries

### Conforming and Auxiliary Anodes/Cathodes

- » For All Plating and Anodizing Processes
- » Manufactured with Titanium, Lead, Stainless Steel, or Steel
- » Manufactured with Bar Stock, Round Stock, Perforated, and/or Expanded Metals
- » Coated with Iridium Oxide or Platinum (for Decorative Chrome Plating)
- » Designed with Current Requirements and Part Geometries Considered
- » Servicing Automotive, Aerospace, Military, and other Industries

### E-Coating Racks

- » Manufactured with Stainless Steel and Steel
- » Uncoated
- » Designed with Part Density, Part Orientation, and Consistent Grounding Considered
- » Servicing Automotive, Heavy Equipment, and other Industries

### Flight Bars

- » For All Plating and Anodizing Processes
- » Manufactured with Copper, Aluminum, Stainless Steel, or Titanium
- » Uncoated or Portions Platisol Coated
- » Designed with Current Requirements, Chemical Exposure, and Hoist Limitations Considered
- » Servicing All Industries

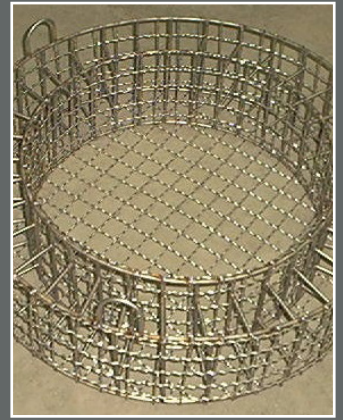

## Custom Tooling and Fabrication continued

### Material Handling Baskets, Carts, and Racks

- » For Storage, Internal Transportation, Domestic Transportation, and or International Transportation
- » Manufactured with Steel, Stainless Steel, or Aluminum
- » Plastisol Coated or Uncoated
- » Designed with Part Protection, Part Density, and Part Security Considered
- » Servicing All Manufacturing Industries

### Plating Barrels

- » New Barrels and Repair of Existing Barrels
- » Manufactured with Poly Propylene
- » Designed with Part Size and Load Size Considered
- » Servicing Fasteners and other Industries

### Metal Fabrication

- » Custom designs
- » Plastisol Coated or Uncoated
- » Capabilities Include:
  - » 3D Printing
  - » Welding (MIG, TIG, Resistance)
  - » Laser Cutting
  - » Water Jet Cutting
  - » Wire Forming
  - » Bending/Braking
  - » Milling
  - » Lathe Work

### Plating Racks (Plastic and Metal Parts)

- » Custom Tooling for all Plating Processes
- » Manufactured with Copper, Stainless Steel, Steel, Titanium, Aluminum, Phosphor Bronze and/or Brass
- » Plastisol Coated or Uncoated
- » Designed with Current Requirements, Part Orientation, Part Density, Part Protection, Ergonomic Items, and Weight Considered
- » Servicing Automotive, Aerospace, Heavy Equipment, Agriculture, Plumbing, Hand Tools, Electronics, Medical, Door Hardware, and Home and Office Furniture, Industries, as well as Job Shops





## Custom Tooling and Fabrication continued

### Powder Coat Racks and Hooks

- » Custom Tooling for all Powder Coat Processes
- » Standard and Custom Hooks for Hanging Parts
- » Manufactured with Stainless Steel and Steel
- » Uncoated
- » Designed with Part Orientation, Part Density, Part Protection, Ergonomic Items, and Weight Considered
- » Servicing Automotive, HVAC, Hardware, and Appliance Industries, as well as Job Shops

### Printed Circuit Board (PCB) Racks

- » Custom Tooling for Copper, Electroless Nickel, and Electroless Gold Plating
- » Manufactured with Copper, Stainless Steel, and Steel
- » Plastisol Coated, Halar Coated, or Uncoated
- » Designed with Current Requirements, Board Size, Board Thickness, and Weight Considered.
- » Servicing the Electronics Industry

### Processing Baskets

- » Custom Tooling for Plating, Electroless Plating, Powder Coating, Painting, and Cleaning Processes
- » Manufactured with Stainless Steel, Steel, or Titanium
- » Manufactured with Bar Stock, Round Stock, Perforated, and/or Expanded Metals
- » Designed with Part Orientation, Part Density, Part Security, and Weight Considered
- » Servicing the Automotive, Aerospace, Medical, Plumbing, Electronics, and Door Hardware Industries, as well as Job Shops

### Wet Paint Racks and Hooks

- » Custom Tooling for all Paint Processes
- » Custom Tooling for Metal and Plastic Parts
- » Standard and Custom Hooks for Hanging Parts
- » Manufactured with Stainless Steel and Steel
- » Uncoated
- » Designed with Part Orientation, Part Density, Part Protection, Ergonomic Items, and Weight Considered
- » Servicing the Automotive, Aerospace, Heavy Equipment, Agriculture, and Appliance Industries, as well as Job Shops



**EPSI HEADQUARTERS**

4221 Courtney Rd.  
Franksville, WI 53126  
USA

866-ASK-EPSI  
[sales@epsi.com](mailto:sales@epsi.com)  
[www.epsi.com](http://www.epsi.com)

